

# HUSH ROUND

Designed by David Trubridge

PLN GROUP

---

## Overall Dimensions - Model: 1017-B (240V)

---

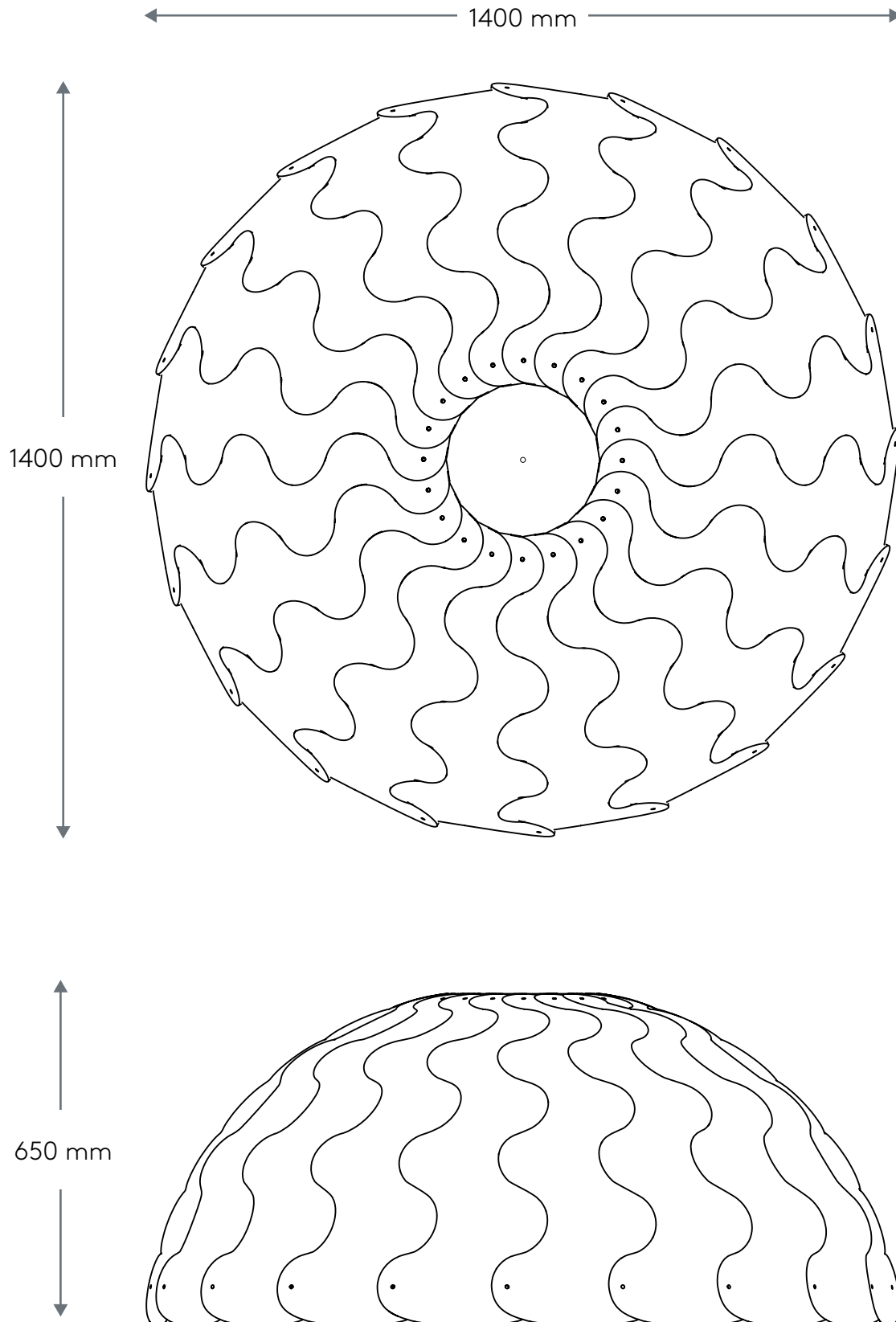

---

## Contents (not to scale)

---

Please double check all components are present and quantities are correct before beginning assembly

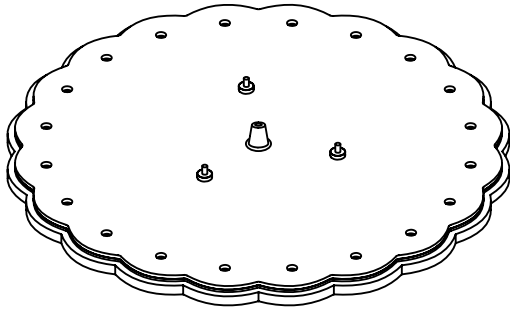

x1  
Top Panel Assembly  
(Power cable not shown)

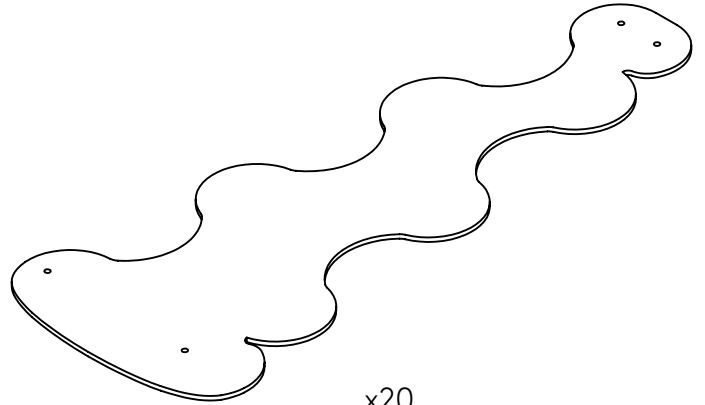

x20  
Tapered Felt Panels

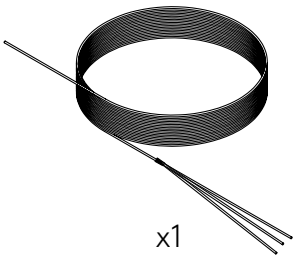

x1  
2.1m cable



x40 (+5)  
Small Ratchet Rivets  
(13mm)



x40 (+5)  
Large Ratchet Rivets  
(19mm)

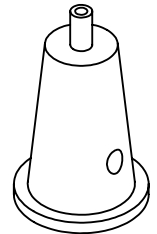

x1  
Cone Gripper  
with Base

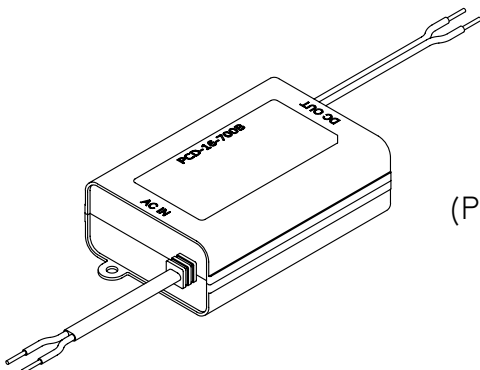

x1  
LED Driver  
(PCD-16-700B)

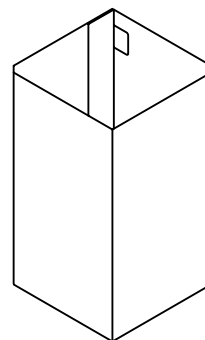

x2  
Folded  
Cardboard  
Pillars

## Step 1 - Top Panel Ratchet Rivet Assembly

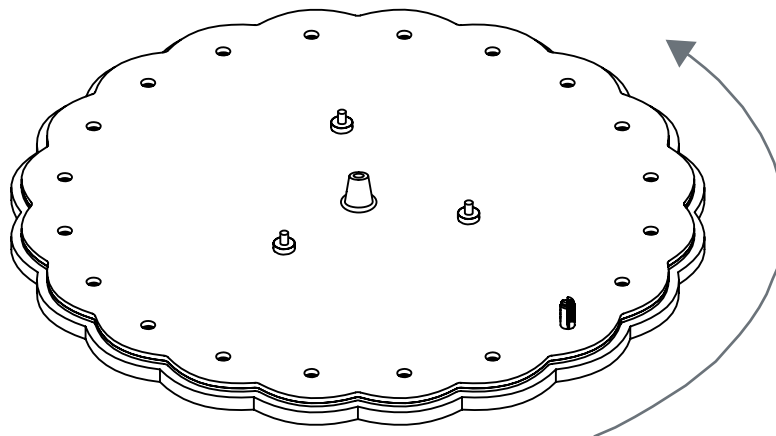
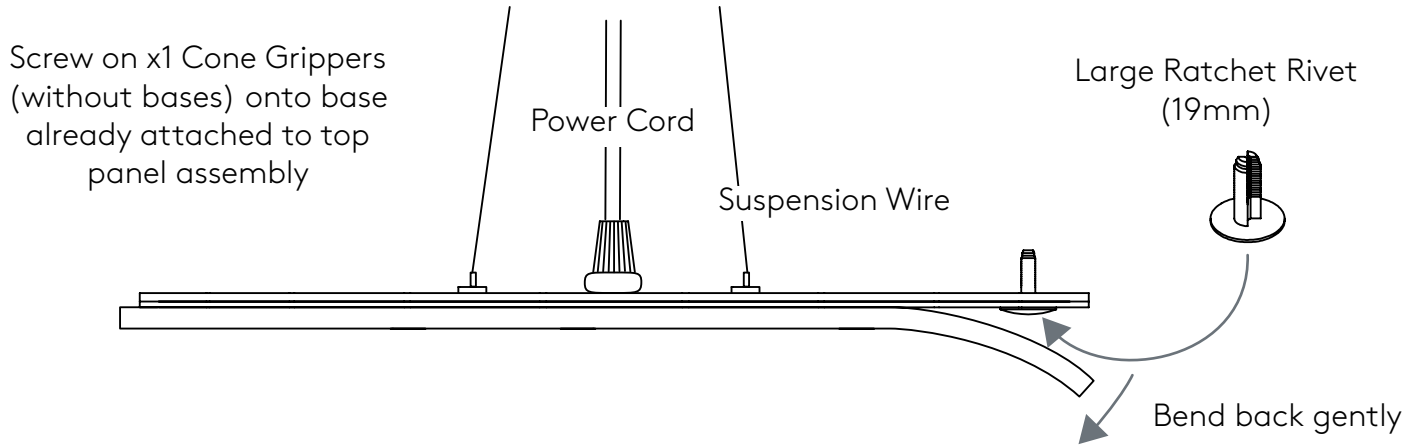

Insert Large Ratchet Rivets (.74in / 19mm) in all holes around edge.

(power cord and suspension wires not shown)

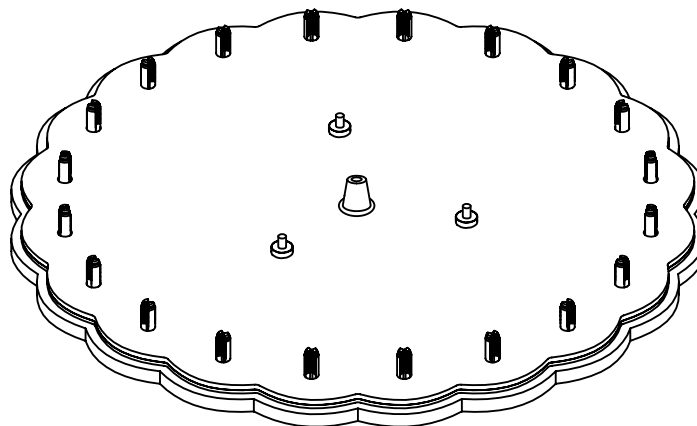

---

## Step 2 - Pop out side panel plugs

---

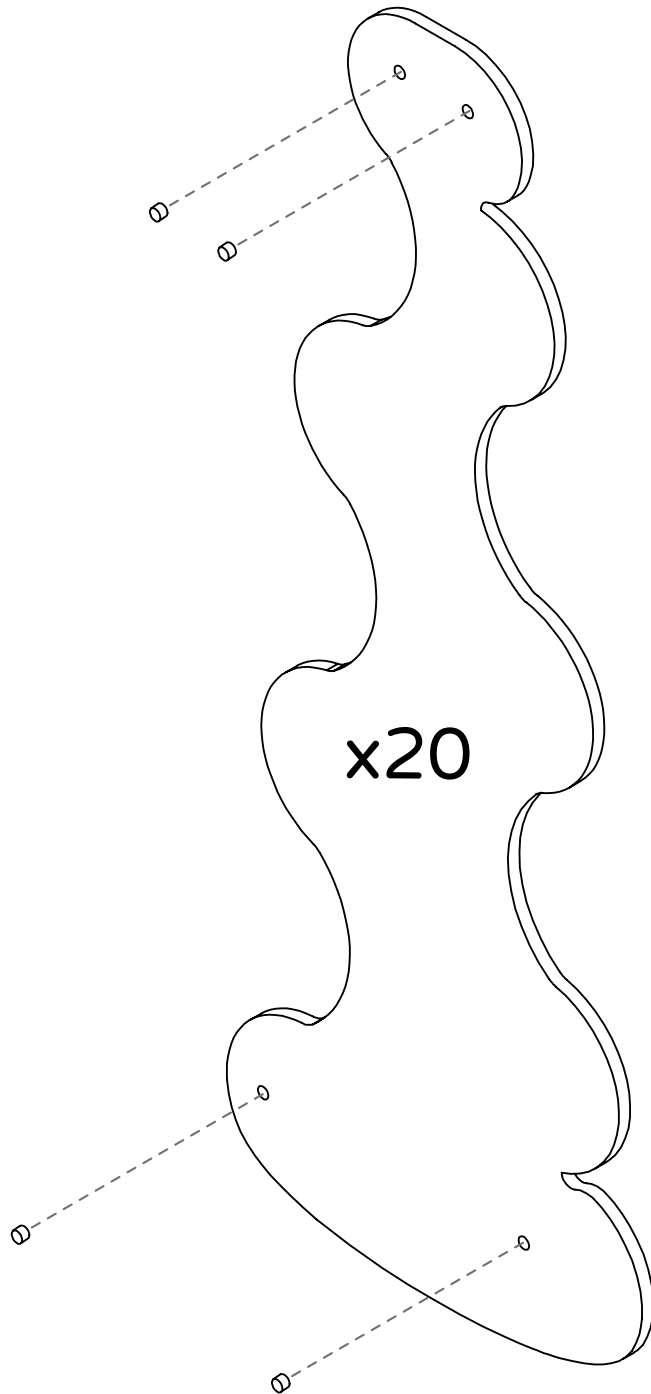

Push out the 4 plugs per panel to make way for the plastic clips.

## Step 3 - Top Panel to Side Panel Assembly

Assemble on a large clean surface or on floor.

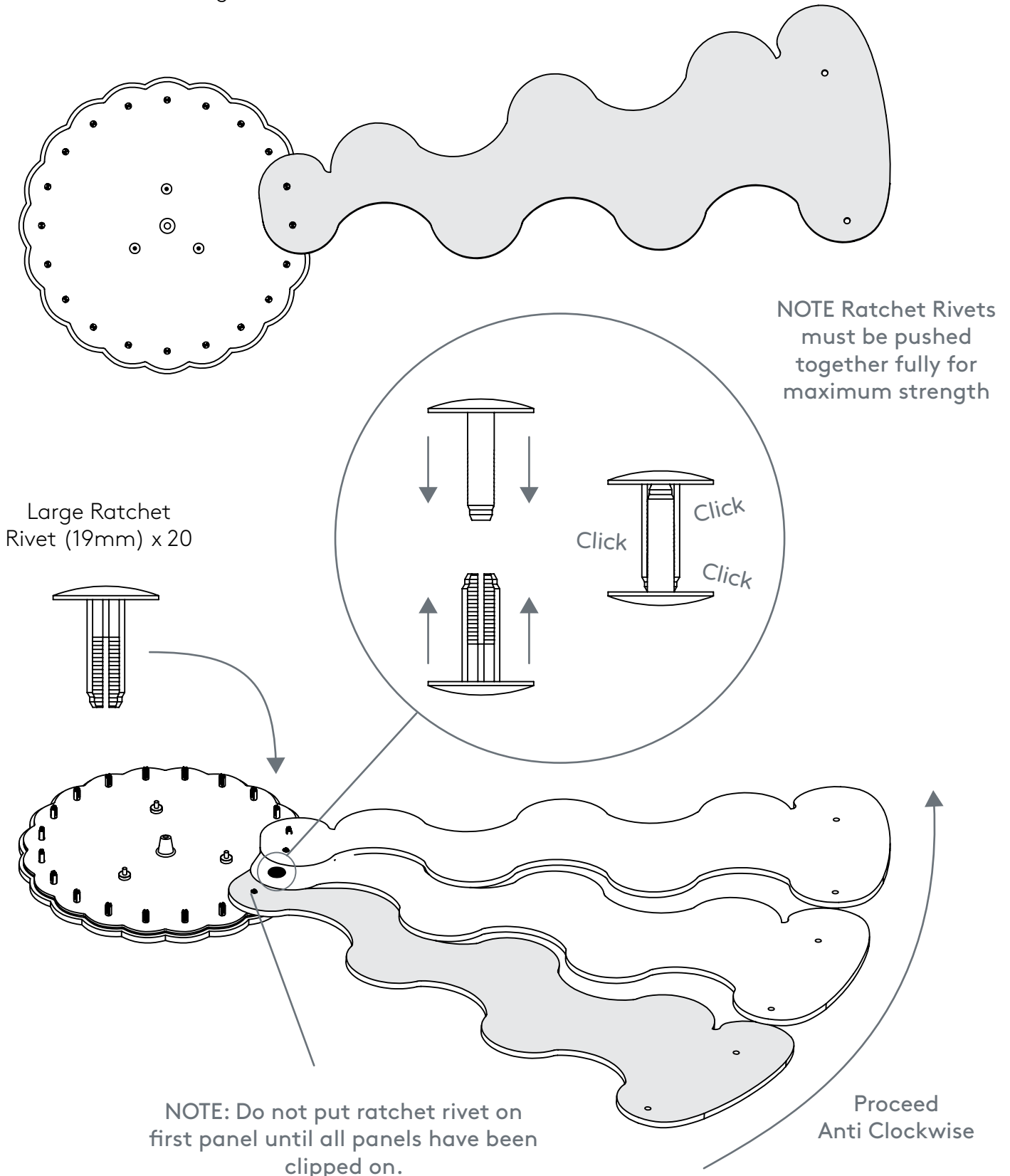

## Step 4 - Top Panel to Side Panel Assembly Continued

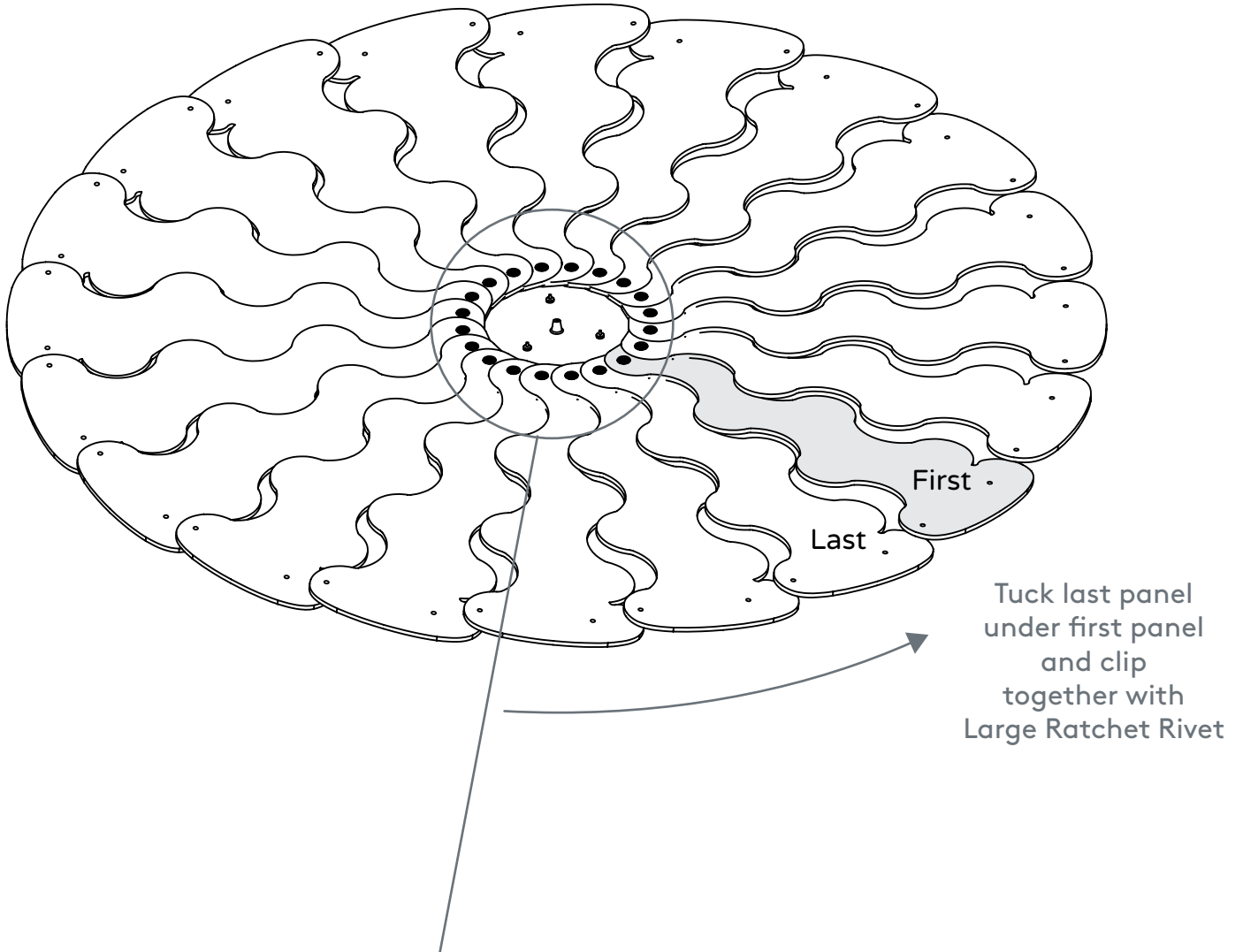

Cross Section Detail View of Top Panels overlapping.

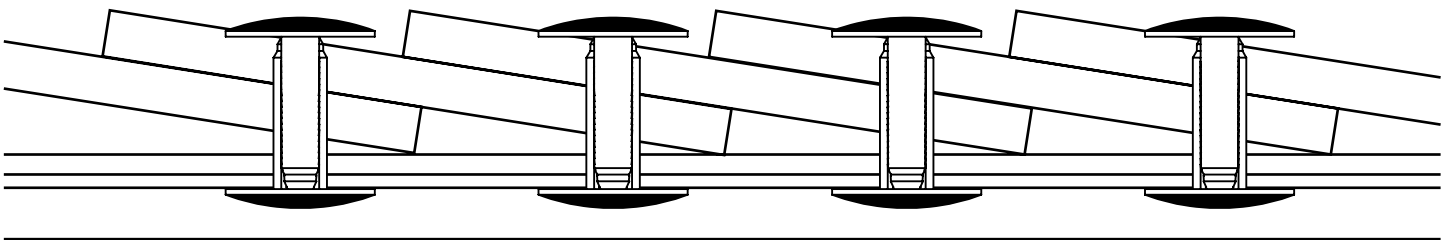

---

## Step 5 - Lifting into shape

---

Use suspension cable to lift the Hush Round approximately 650mm from the floor/surface.

The panels will begin to fall into their natural shape.

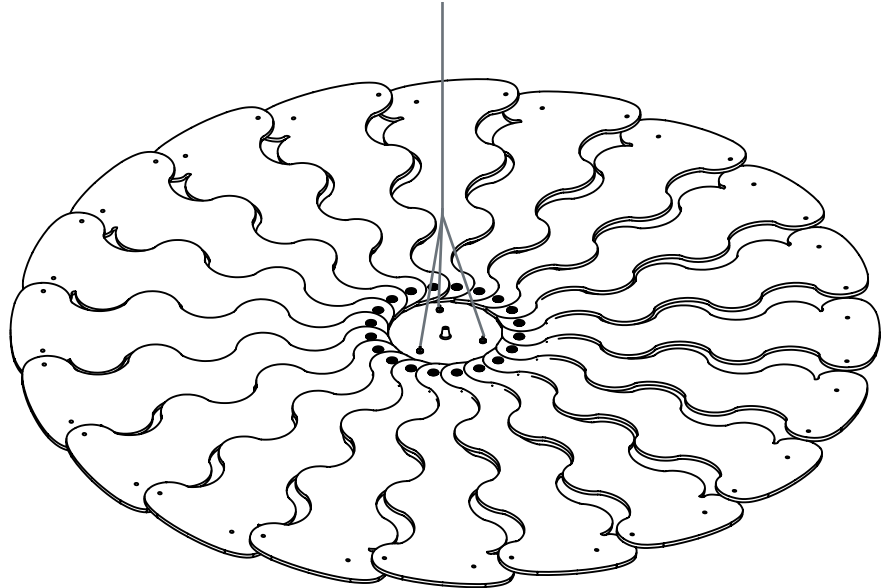

Use the folded cardboard pillar that was in the box (or similar-sized table) to prop it up.

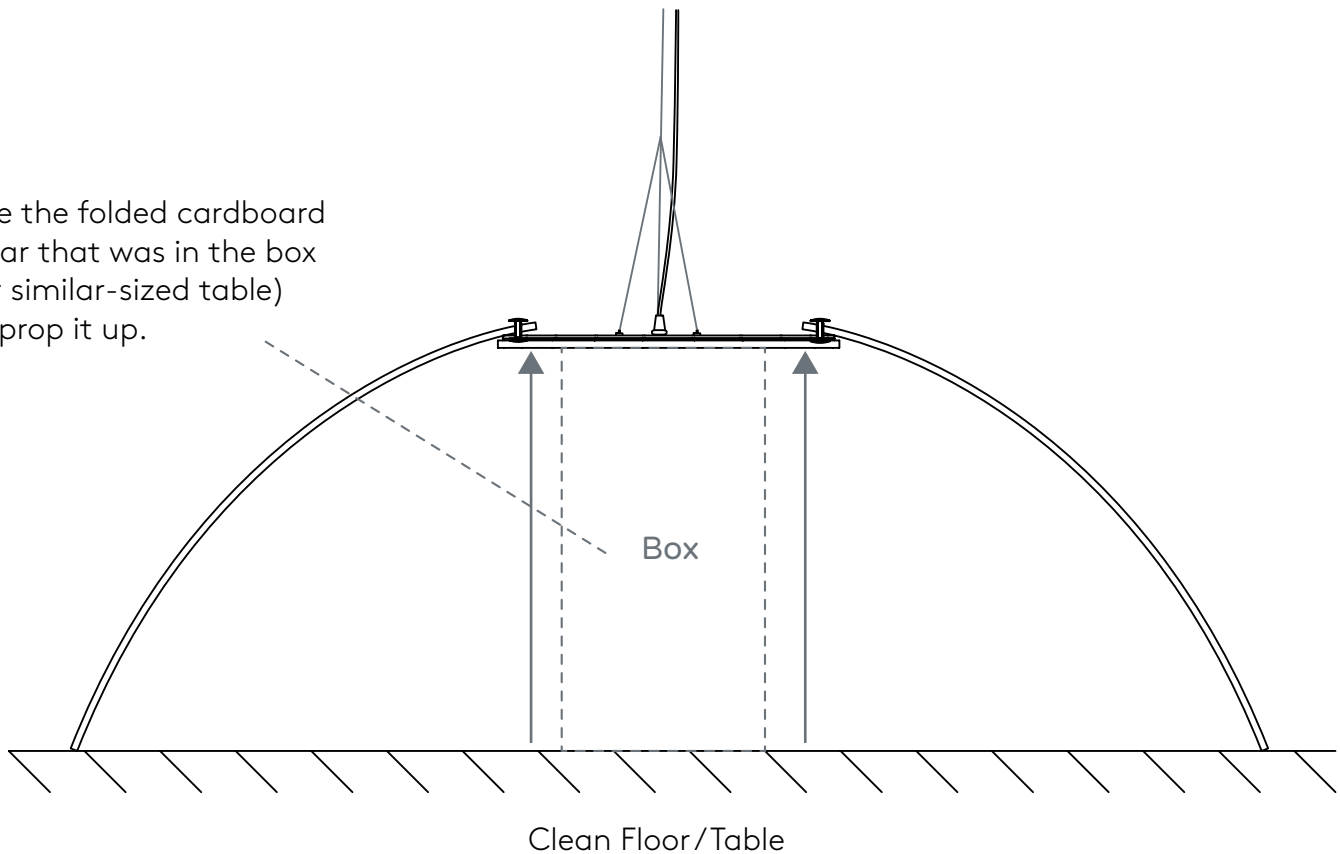

## Step 6A - Weaving of Panels - Exploded Detail

Bold Lines indicate the 'Ear' that sits on the outside of the Hush Round.  
This weaving pattern is essential to lock the shape together

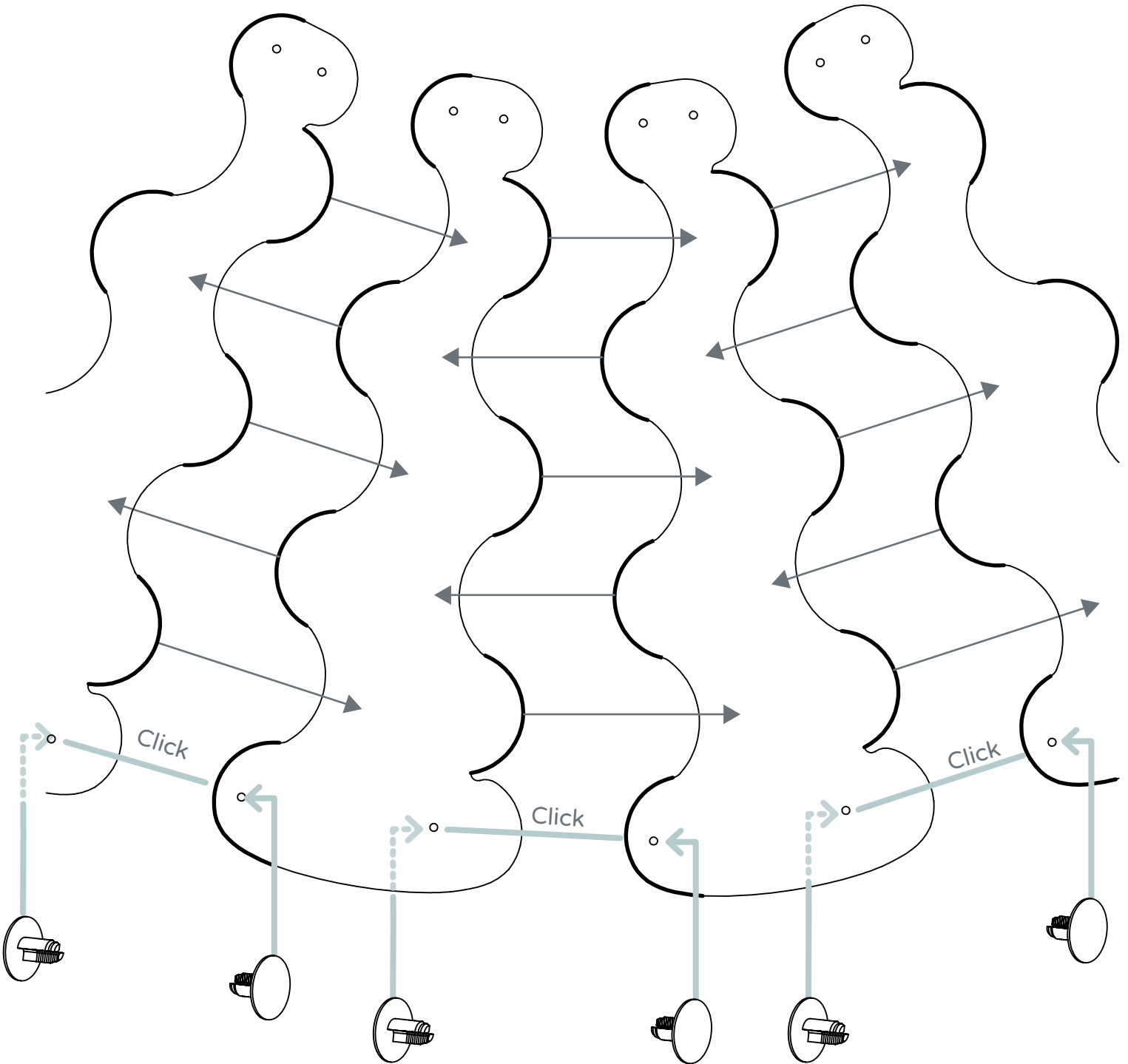

Once two panels are woven together, use two of the shorter Ratchet Rivets (13 mm) to lock them together.



---

## Step 6A - Weaving of Panels - Finished Detail

---

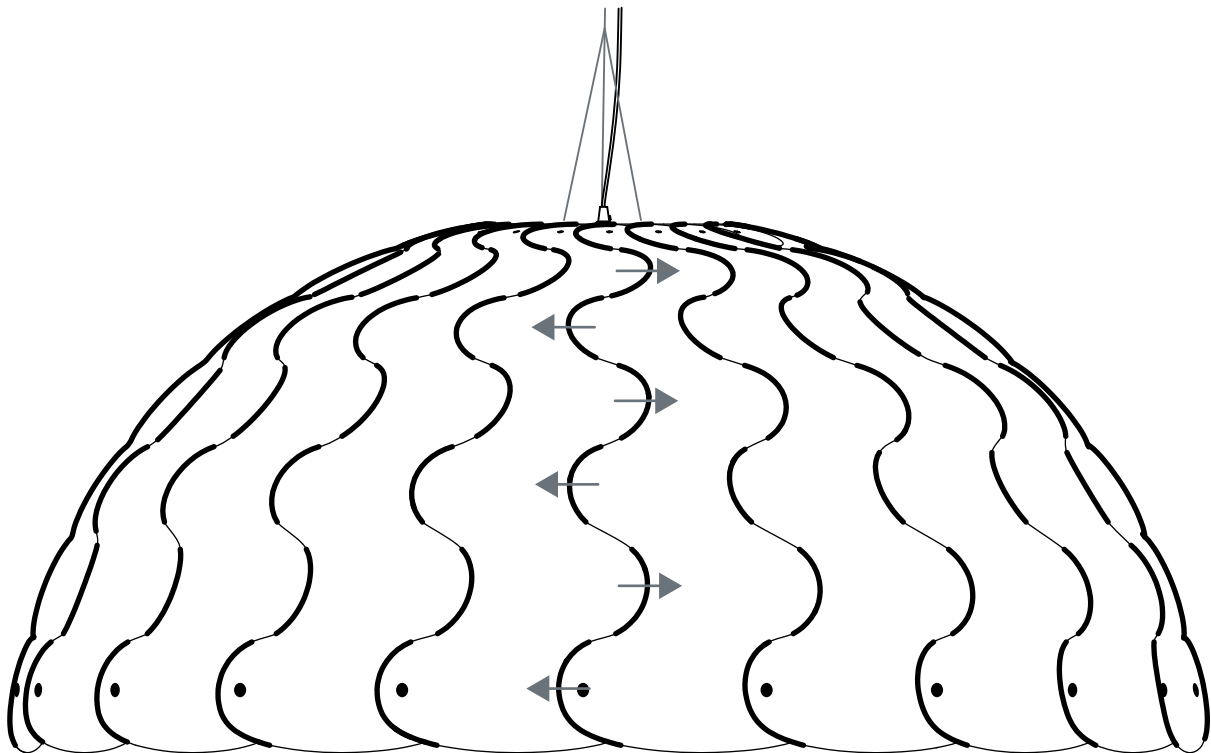

Bold Lines indicate the 'Ear' that sits on the outside of the Hush Round.  
This weaving pattern is essential to lock the shape together

## Step 7 - Height Adjustment and Levelling

### Ceiling Mounting Point.

If installing into wood use a countersunk timber screw (not supplied) to affix cone grip to ceiling.

If installing into concrete use countersunk anchor bolt (not supplied) to affix cone grip to ceiling.

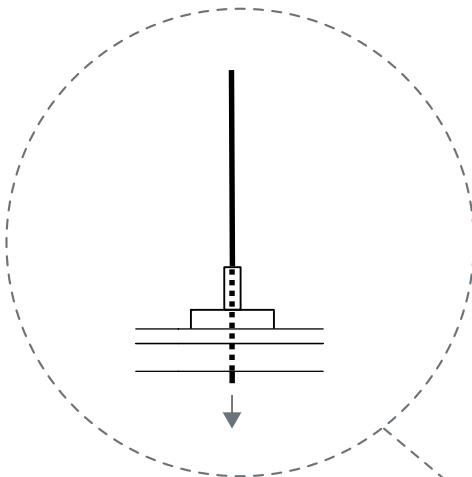

To shorten wire:  
Pull cable through hole  
in side of gripper point

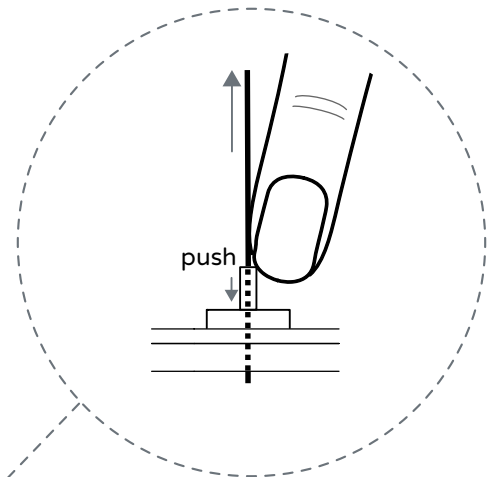
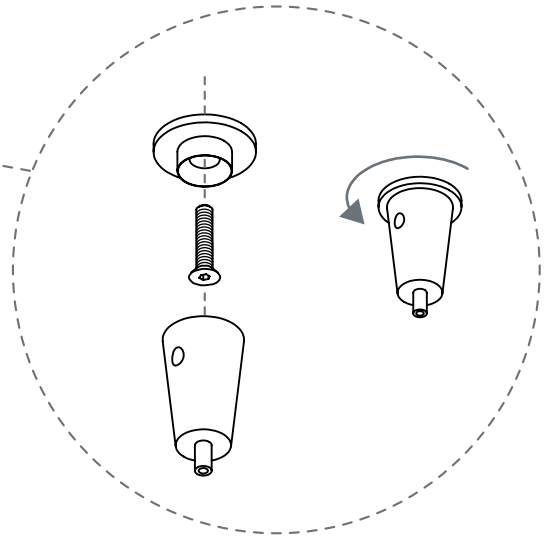

To lengthen wire:  
Depress cylinder at top  
of gripper point and pull  
wire out

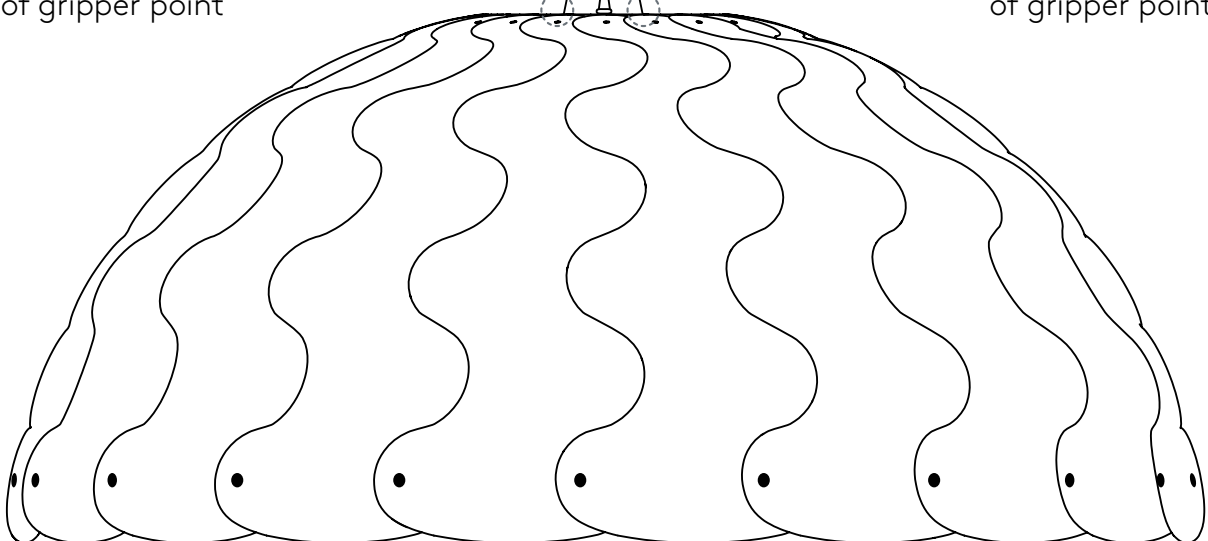

Step 8 - Electrics, Suggested LED driver placement with hanging ceiling

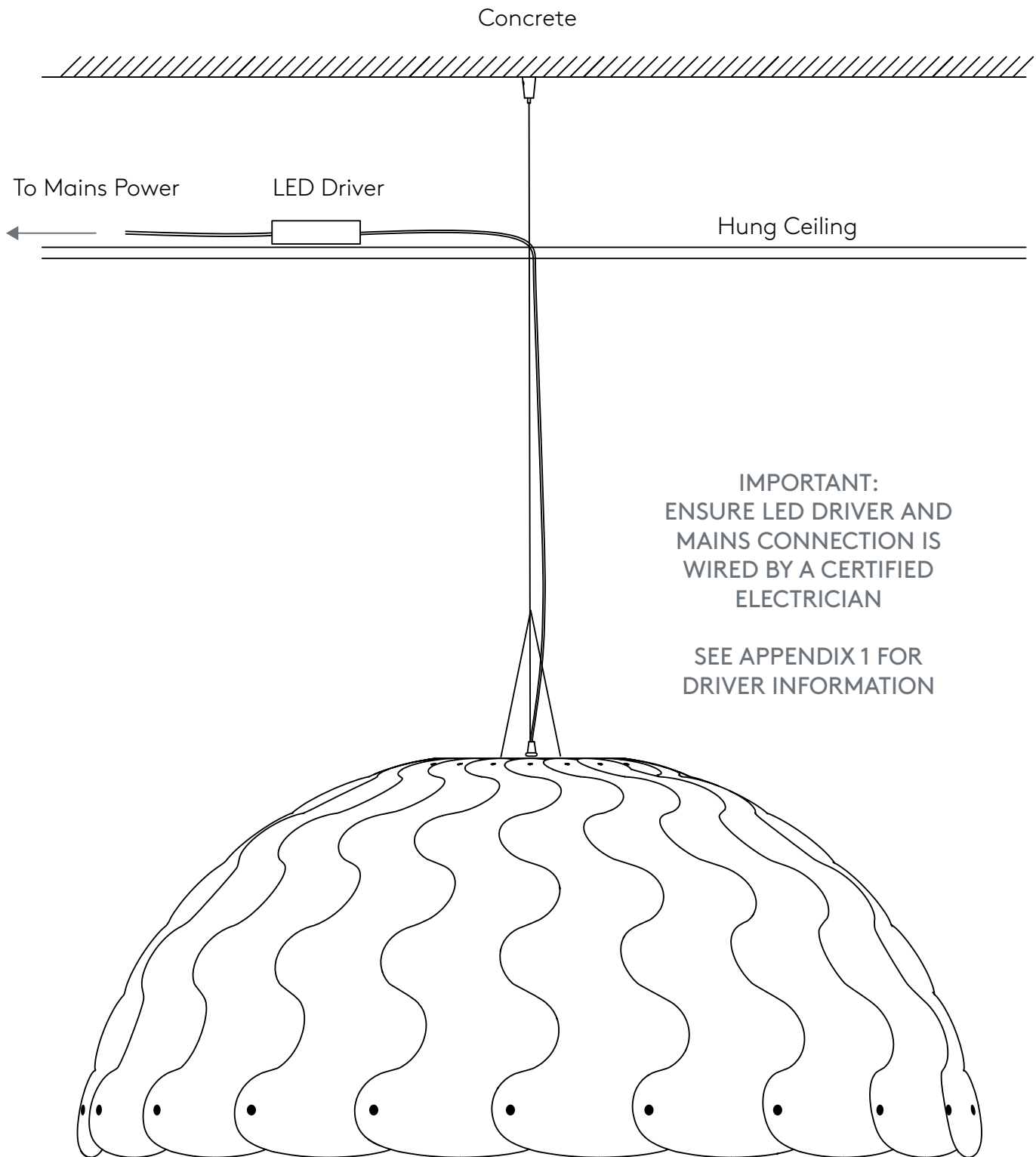

IMPORTANT:  
ENSURE LED DRIVER AND  
MAINS CONNECTION IS  
WIRED BY A CERTIFIED  
ELECTRICIAN

SEE APPENDIX 1 FOR  
DRIVER INFORMATION

---

## Appendix 1: LED Driver Diagram

---

MEANWELL 16W Single Output C Dimmable LED Power Supply  
(PCD-16-700B)

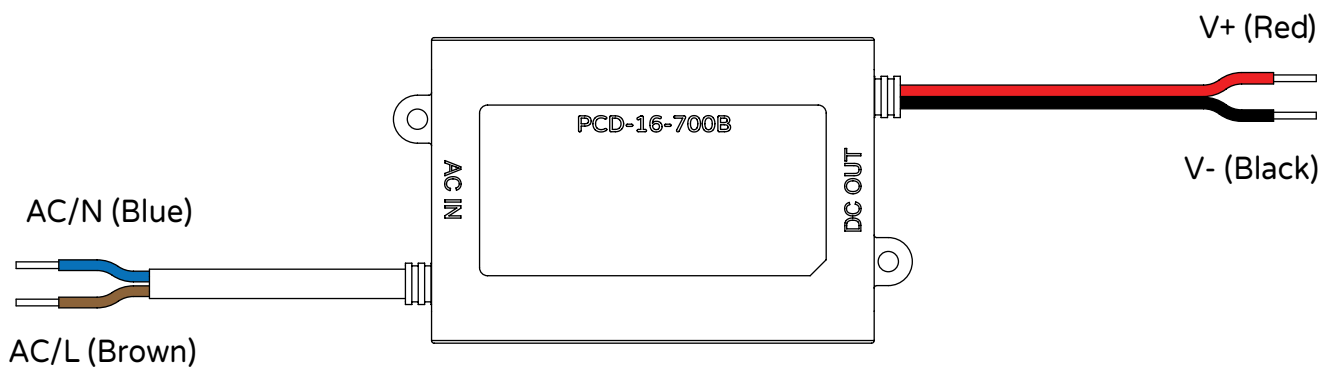

**IMPORTANT:**  
THIS PRODUCT MUST BE INSTALLED IN ACCORDANCE  
WITH THE APPLICABLE INSTALLATION CODE BY A  
PERSON FAMILIAR WITH THE CONSTRUCTION AND  
OPERATION OF THE PRODUCT AND THE HAZARDS INVOLVED

---

Appendix 2: Access to LED Lights for maintenance

---

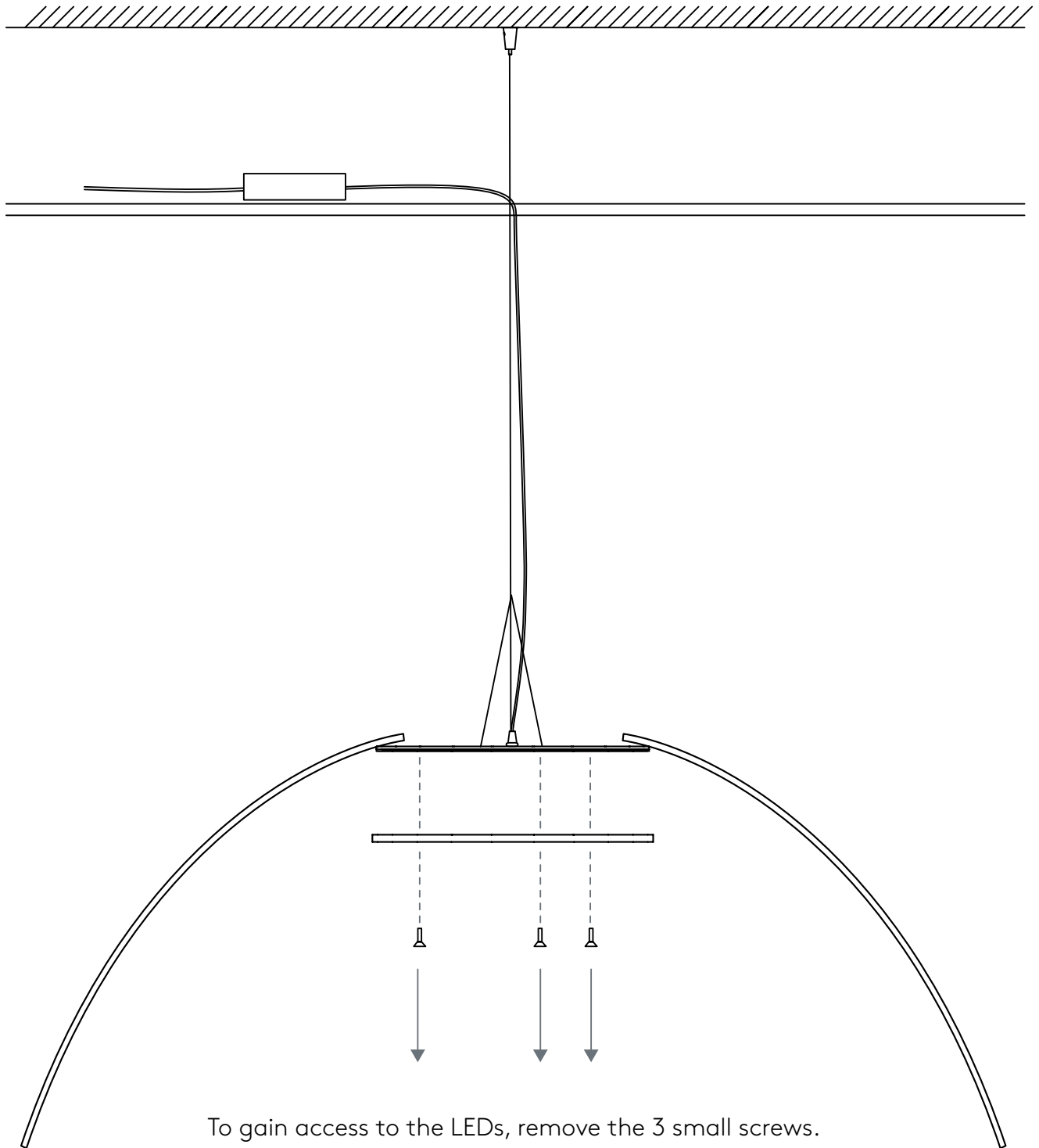

To gain access to the LEDs, remove the 3 small screws.

Appendix 3: Top Panel Sub Assembly

Aluminium Disk  
(LEDs on underside)

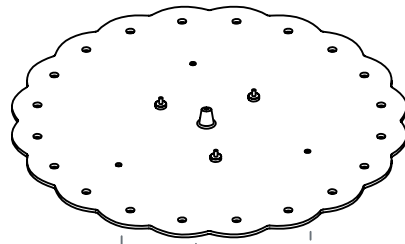

Plastic Spacer Disk

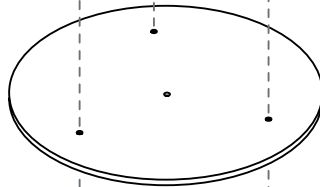

Felt Panel

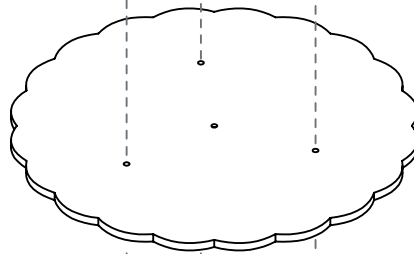

3 x 12mm Screws

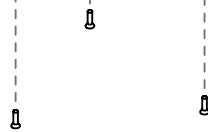

Exploded View

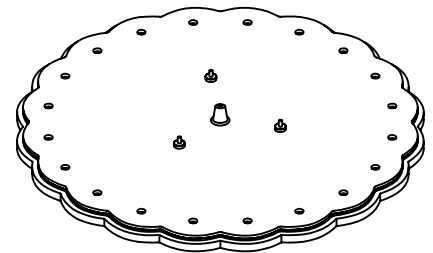

Assembled View