

# HUSH OVAL

Designed by David Trubridge

# PLN GROUP

---

## Overall Dimensions - Model: 1018-A (110V)

---

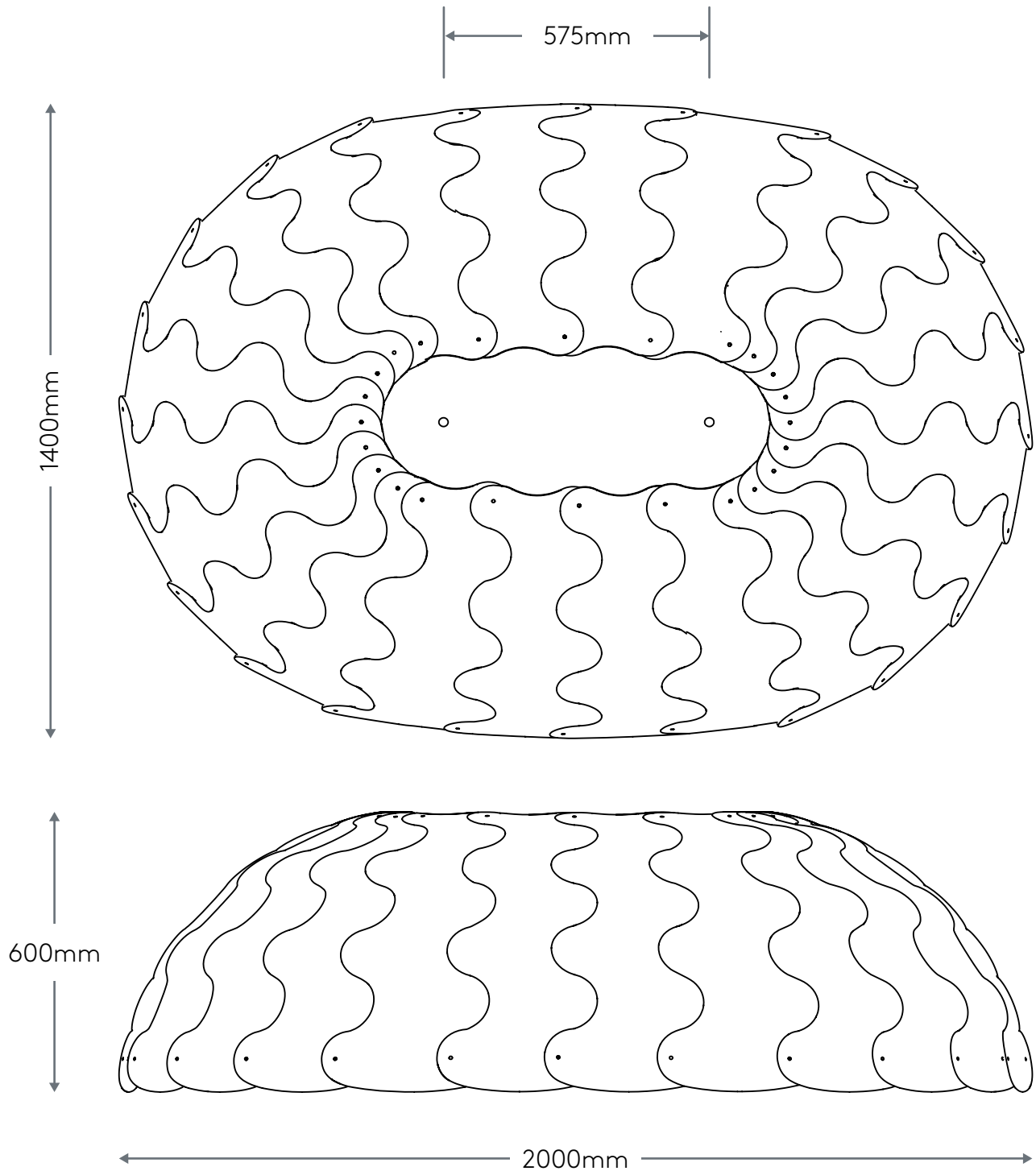

## Contents (not to scale)

Please double check all components are present and quantities are correct before beginning assembly

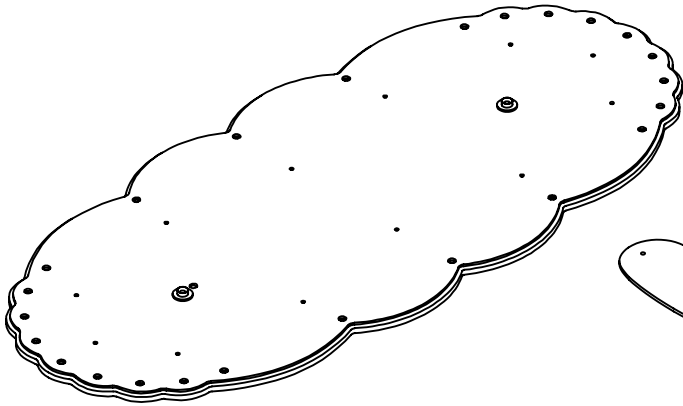

x1  
Top Panel Assembly  
(Power cable not shown)

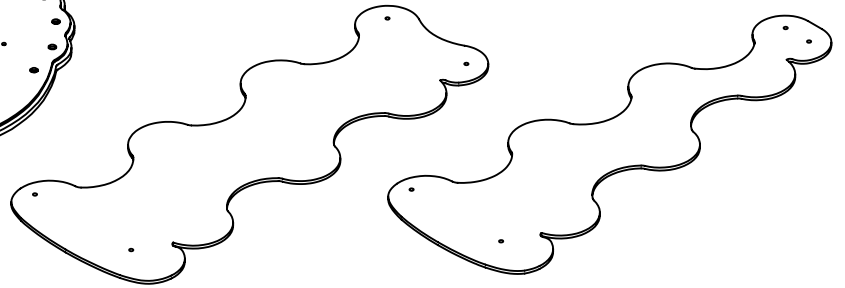

x8  
Straight  
Felt Panels

x16  
Tapered  
Felt Panels

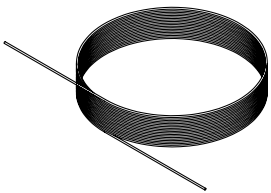

x2  
3m Cable



x48 (+5)  
Small Ratchet  
Rivets (13mm)



x48 (+5)  
Large Ratchet  
Rivets (19mm)

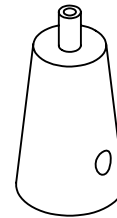

x2  
Cone Gripper  
without Base

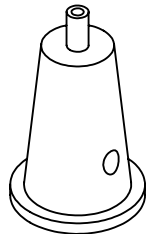

x2  
Cone Gripper  
with Base

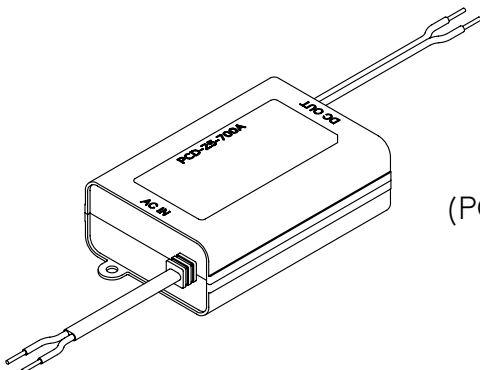

x1  
LED Driver  
(PCD-25-700A)

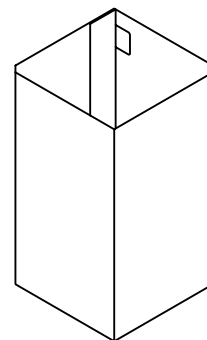

x2  
Folded  
Cardboard  
Pillars

## Step 1 - Top Panel Ratchet Rivet Assembly

Screw on x2 Cone Grippers  
(without bases)  
onto base  
already attached to top  
panel assembly

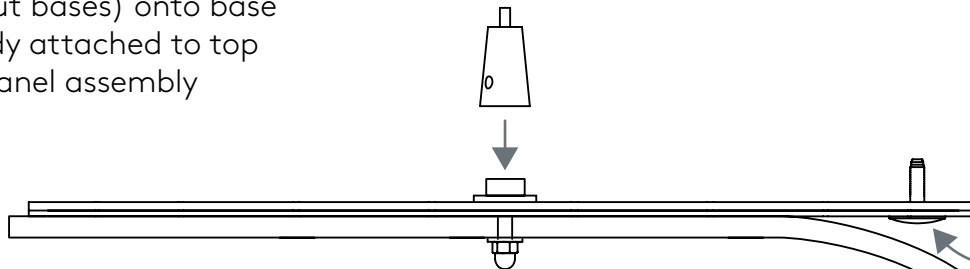

Large Ratchet  
Rivet (19mm)

Bend back gently

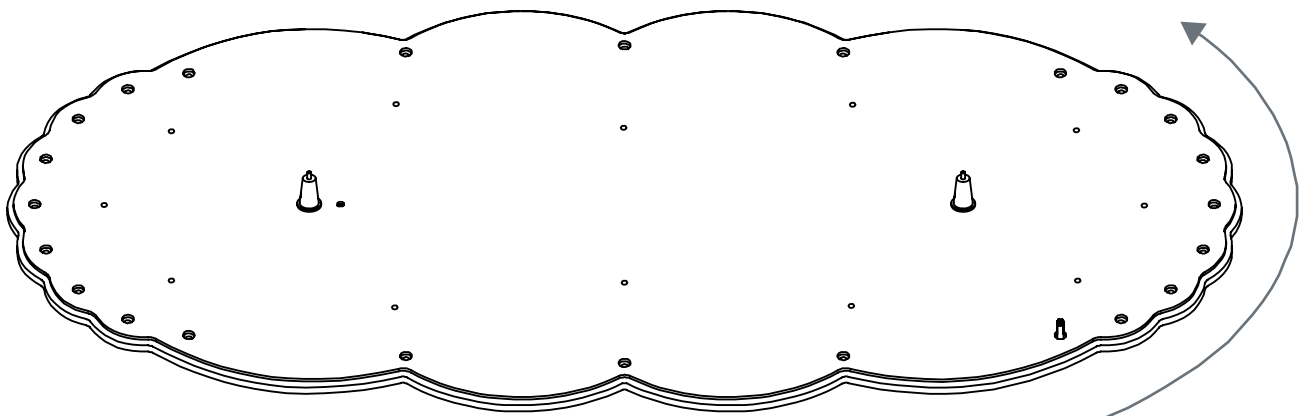

Insert Large Ratchet  
Rivets (19mm) in all  
holes around edge.

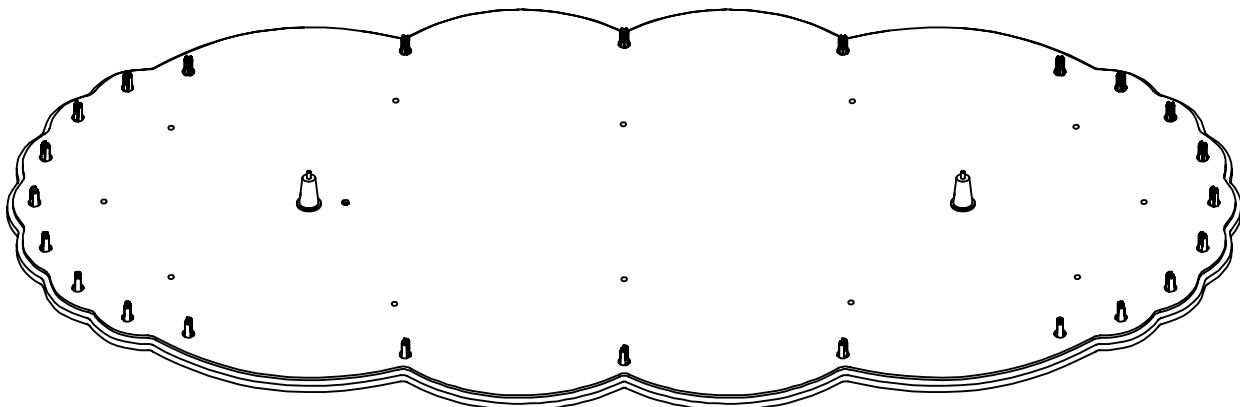

---

## Step 2 - Pop out side panel plugs

---

Push out the 4 plugs per panel to make way for the plastic clips.

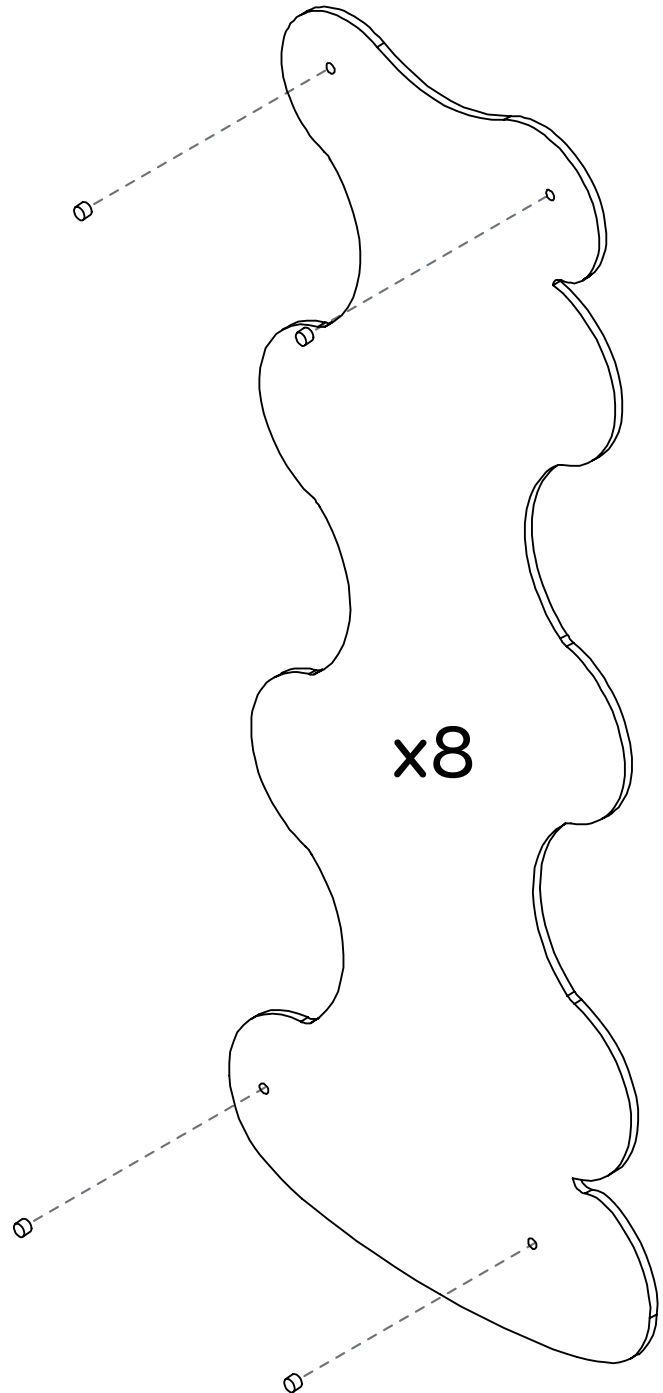
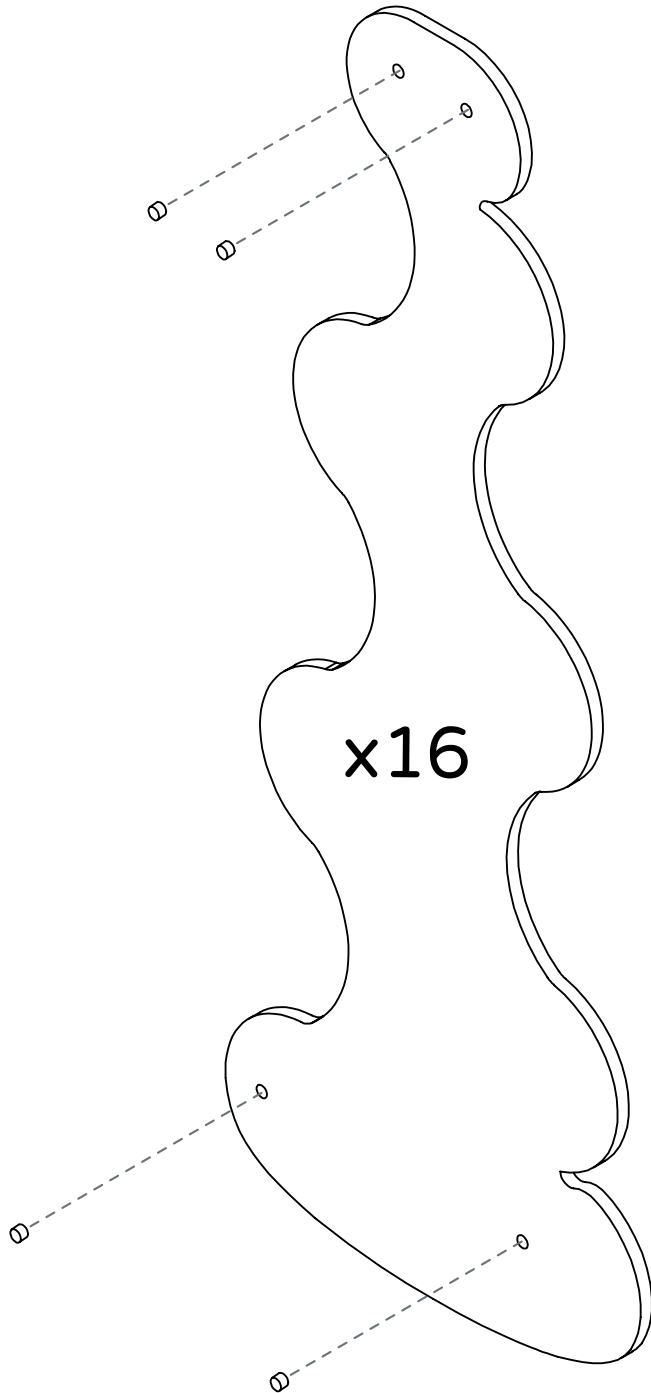

## Step 3 - Top Panel to Side Panel Assembly

Assemble on a large clean surface or on floor.

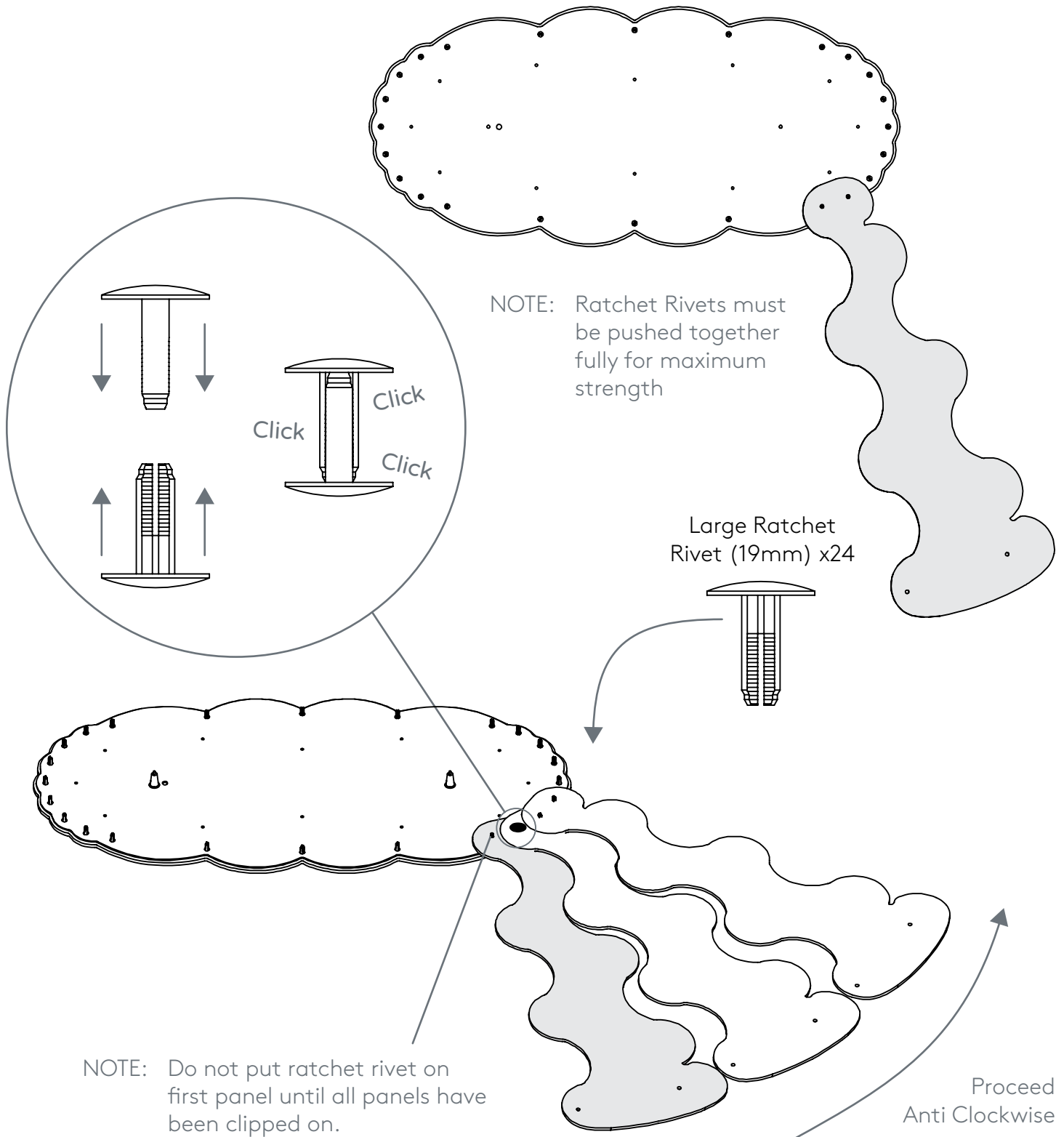

---

## Step 4 - Top Panel to Side Panel Assembly Continued

---

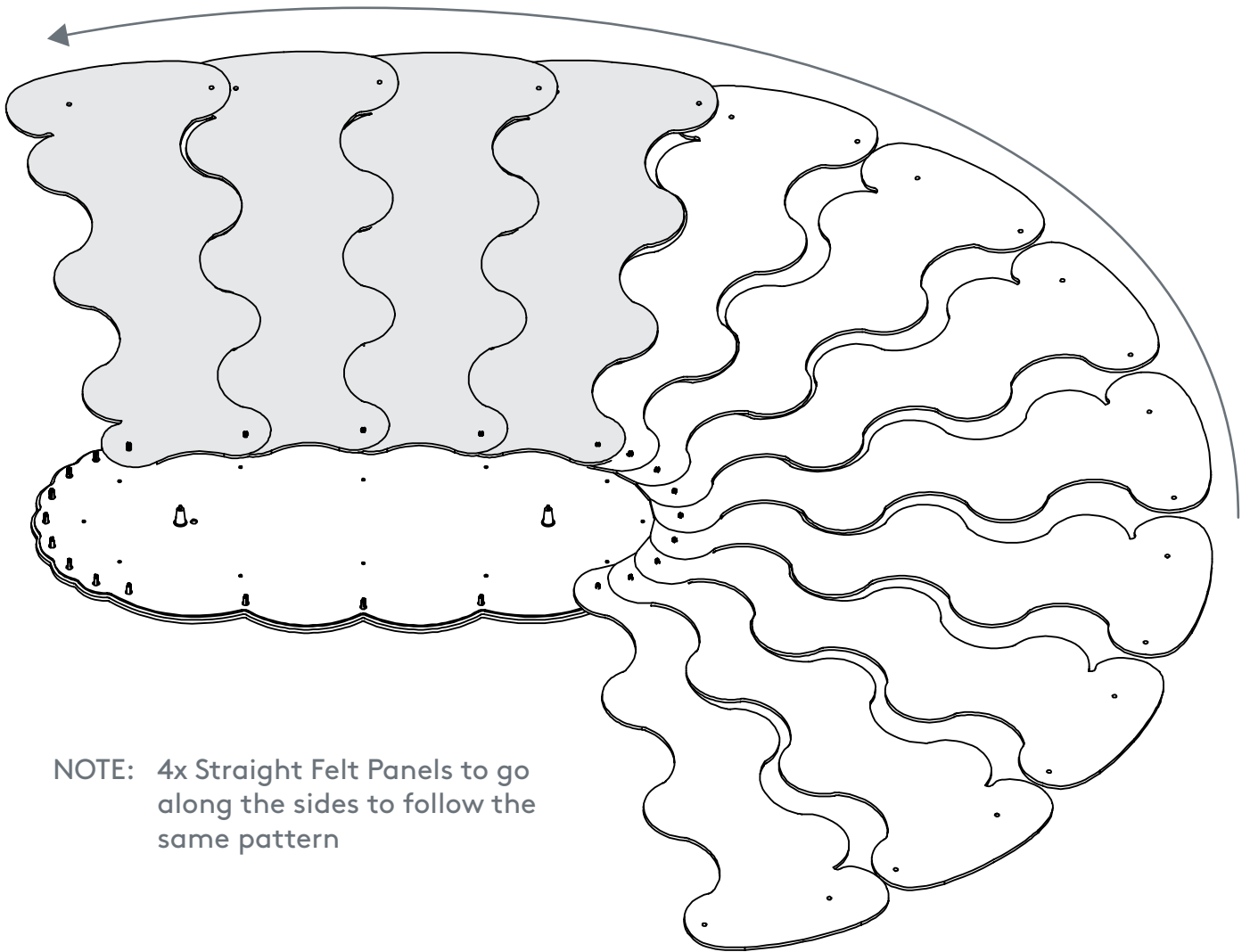

**NOTE:** 4x Straight Felt Panels to go along the sides to follow the same pattern

Step 4 - Top Panel to Side Panel Assembly Continued

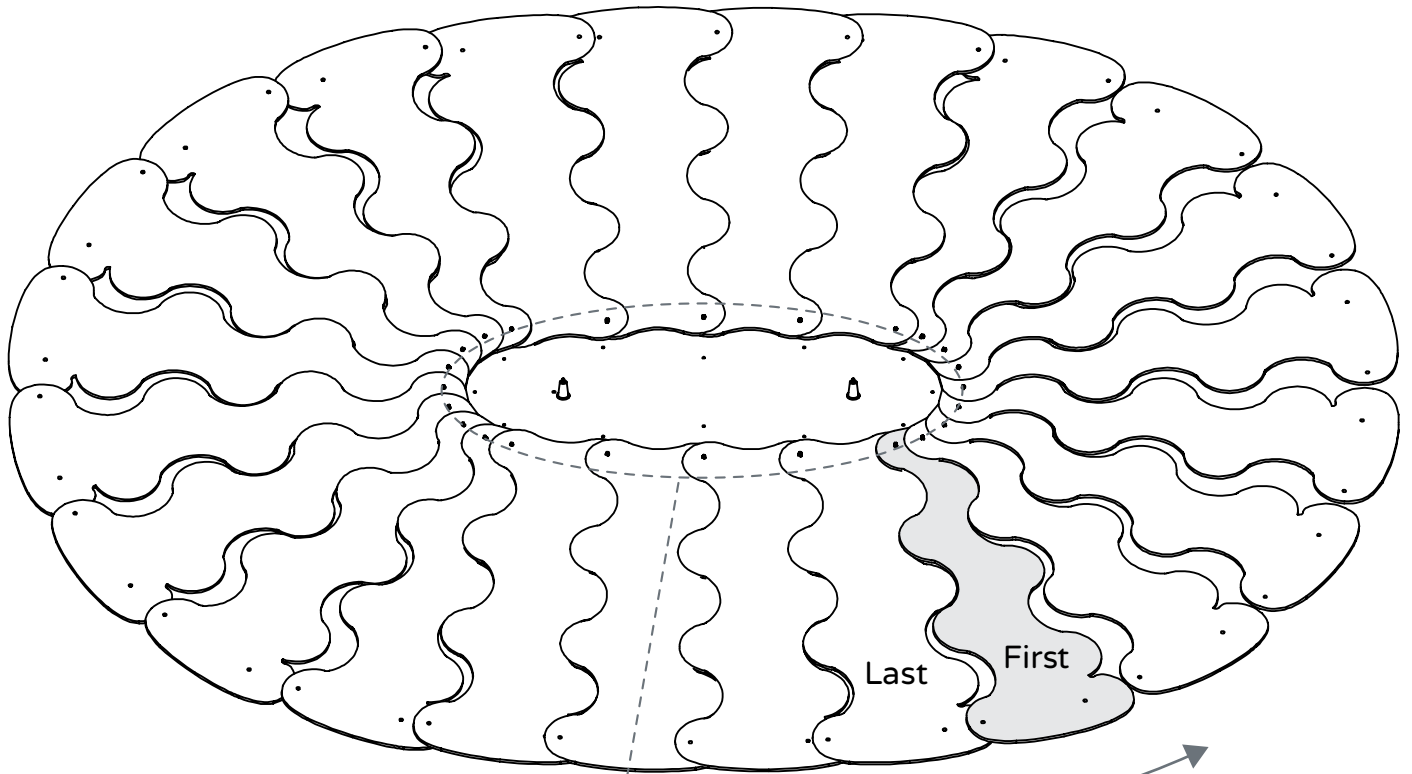

Tuck Last panel under First panel and clip together with Large Ratchet Rivet (19mm)

Cross Section Detail View of Top Panels overlapping.

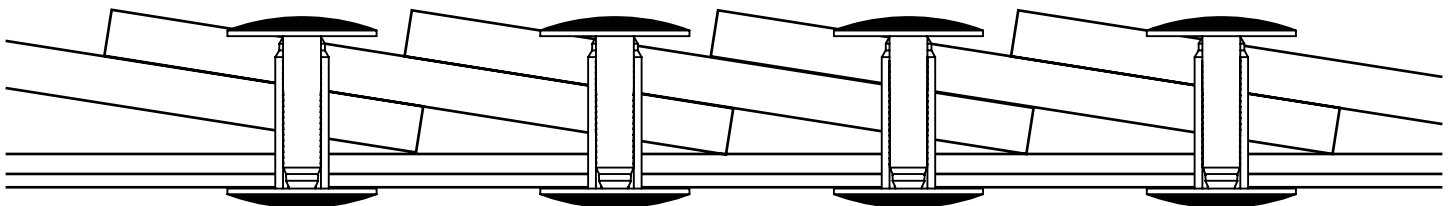

## Step 5 - Lifting into shape

Insert cables into Gripper Cones and use it to lift the Hush Oval approximately 600mm from the floor/surface.

The panels will begin to fall into their natural shape.

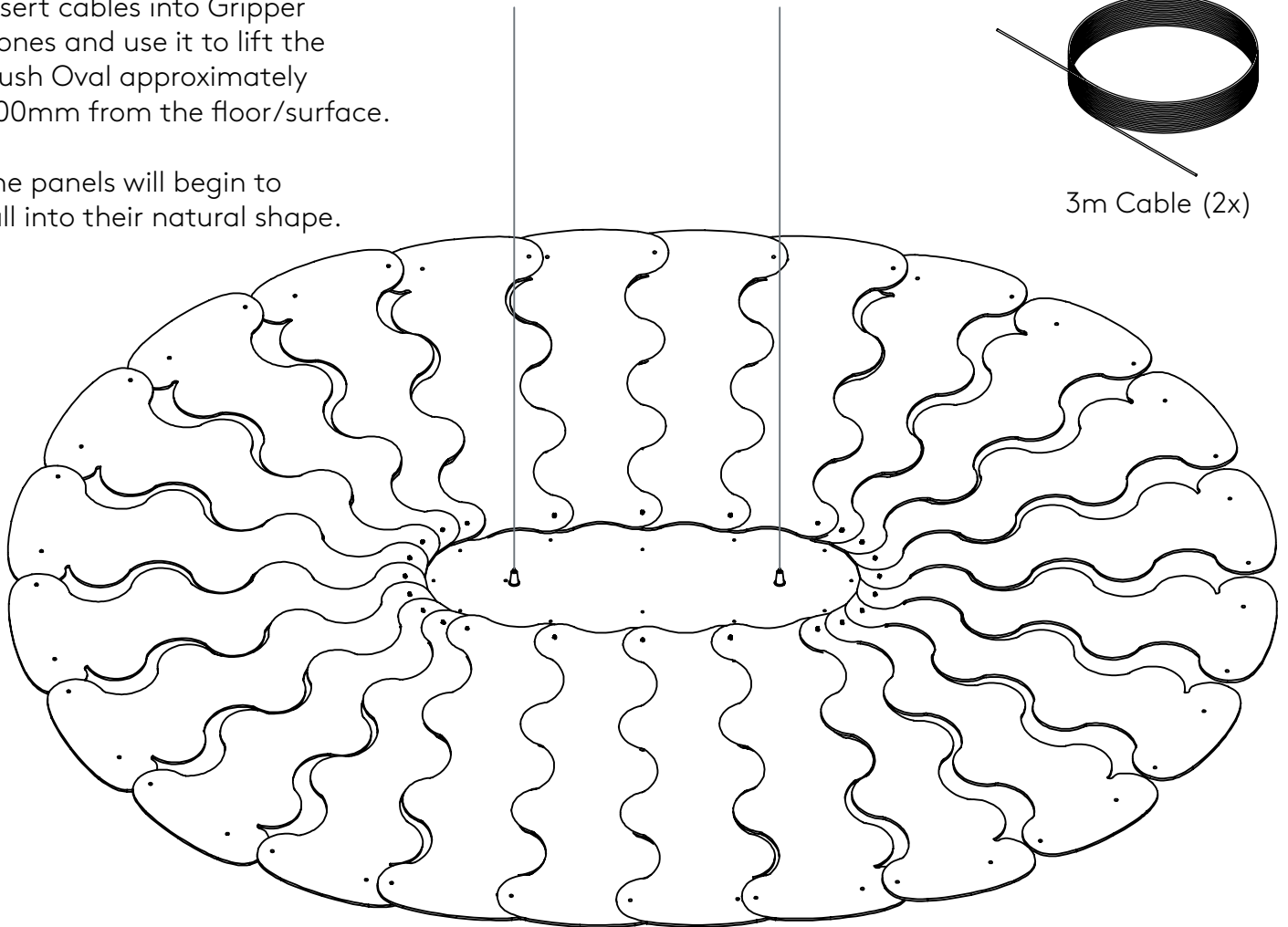
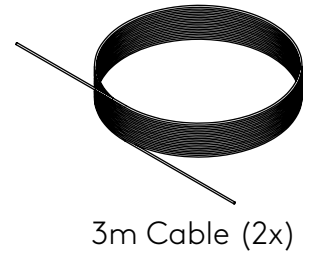

**IMPORTANT:**  
ENSURE YOU ONLY USE THE 2x  
STEEL CABLES TO  
LIFT THE OVAL HUSH LIGHT

Use the folded cardboard pillar that was in the box to prop it up.

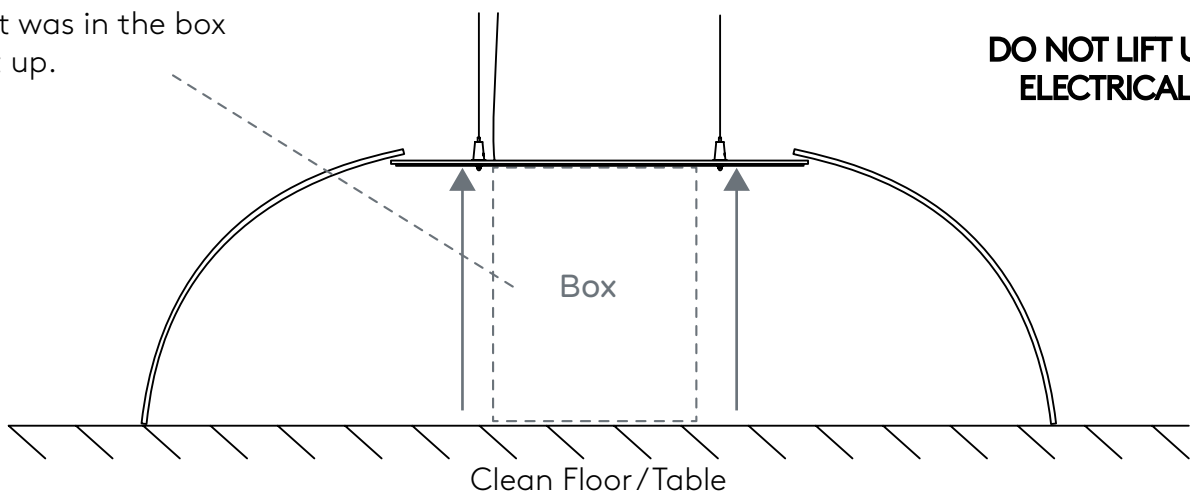

**DO NOT LIFT USING  
ELECTRICAL WIRE**



## Step 6A - Weaving of Panels - Exploded Detail

Bold Lines indicate the 'Ear' that sits on the outside of the Hush Round.  
This weaving pattern is essential to lock the shape together

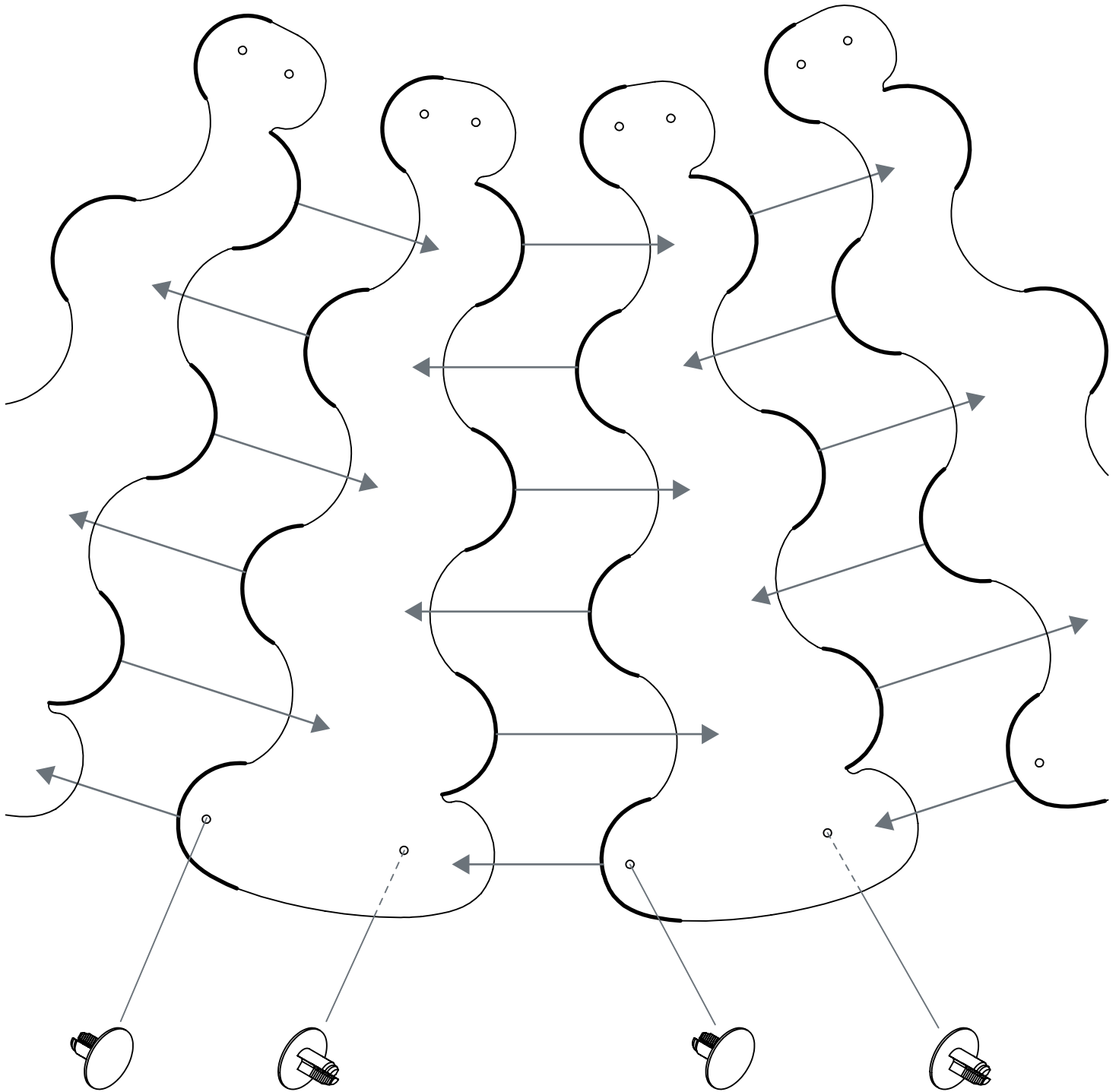

Once two panels are woven together, use two of the shorter Ratchet Rivets (13mm) to lock them together

---

Step 6A - Weaving of Panels - Finished Detail

---

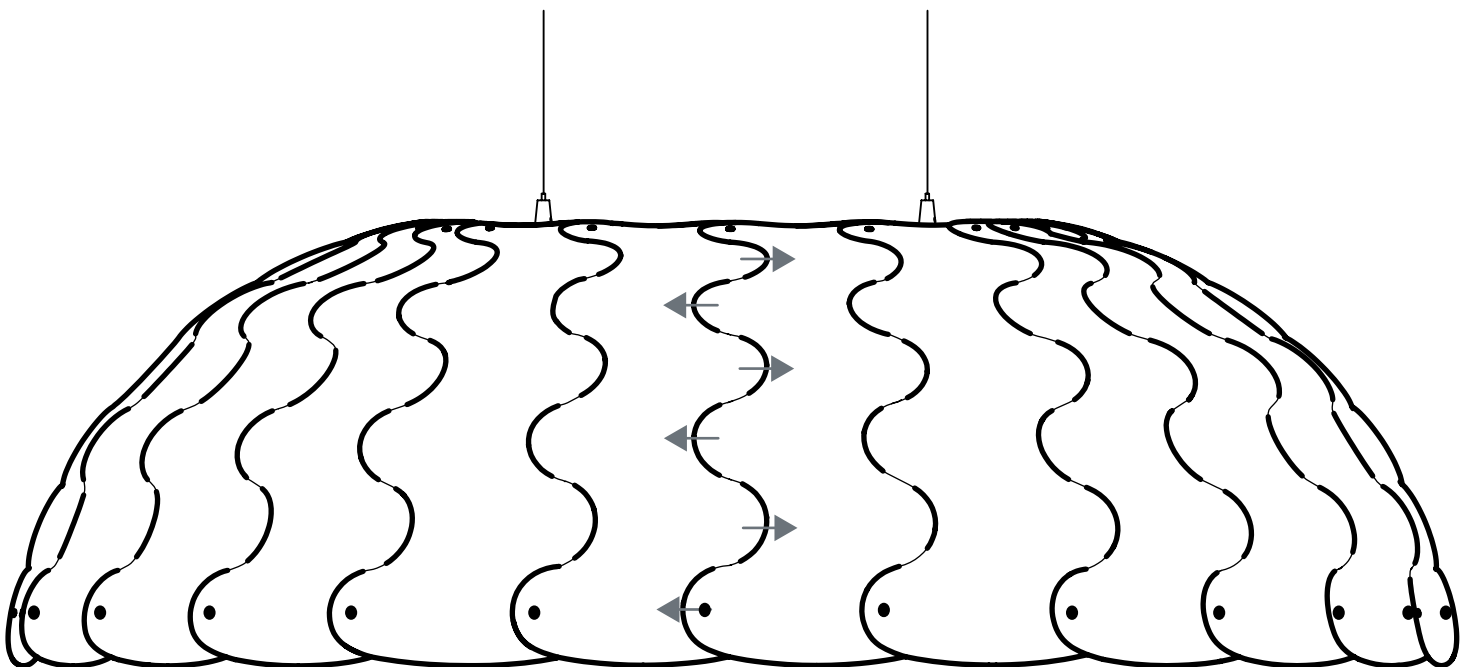

Bold Lines indicate the 'Ear' that sits on the outside of the Hush Oval.  
This weaving pattern is essential to lock the shape together

## Step 7 - Height Adjustment and Levelling

### Ceiling Mounting Point.

If installing into wood use a countersunk timber screw (not supplied) to affix cone grip to ceiling.

If installing into concrete use countersunk anchor bolt (not supplied) to affix cone grips to ceiling.

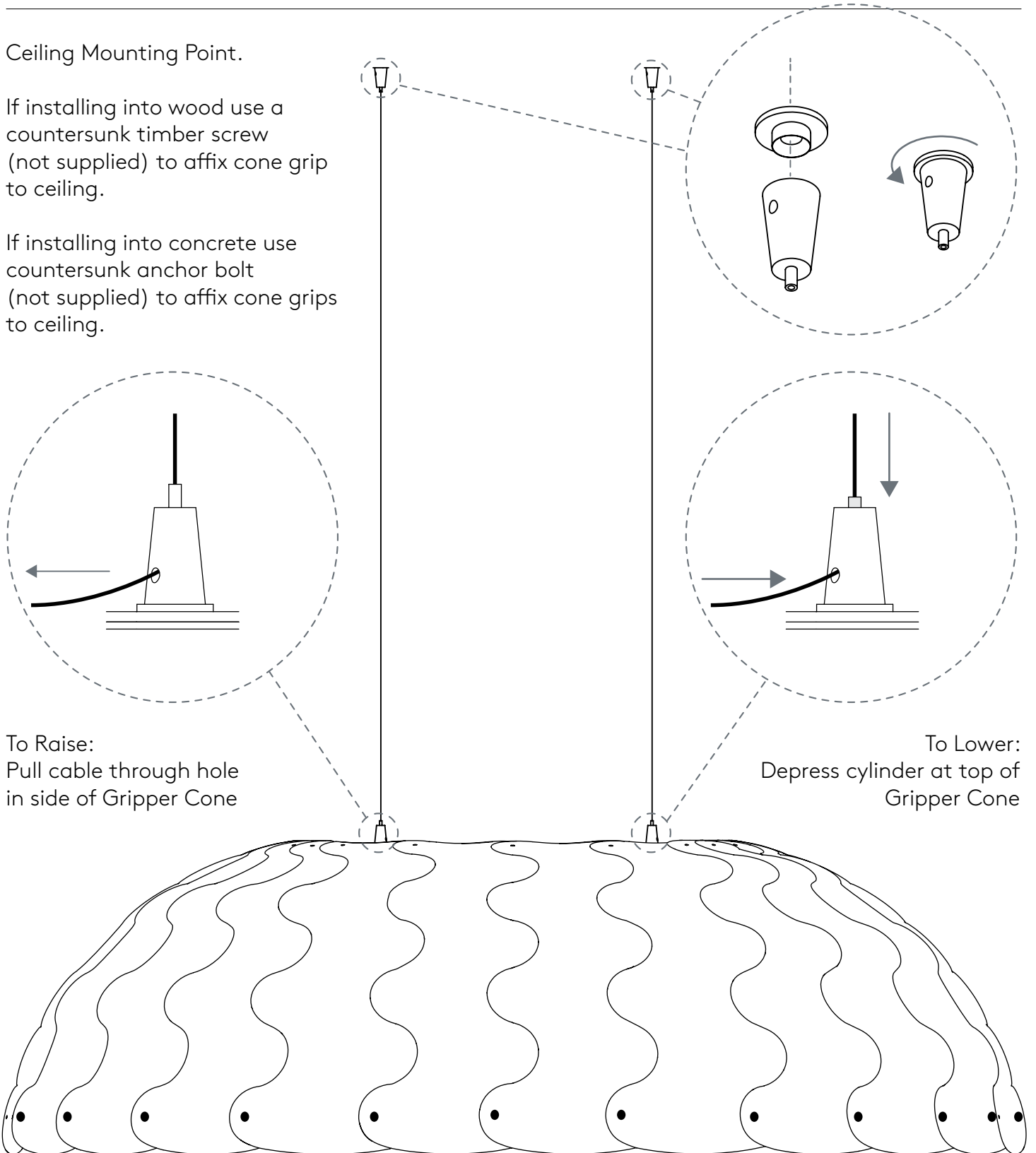

To Raise:  
Pull cable through hole  
in side of Gripper Cone

To Lower:  
Depress cylinder at top of  
Gripper Cone

## Step 8 - Electrics, Suggested LED driver placement with hanging ceiling

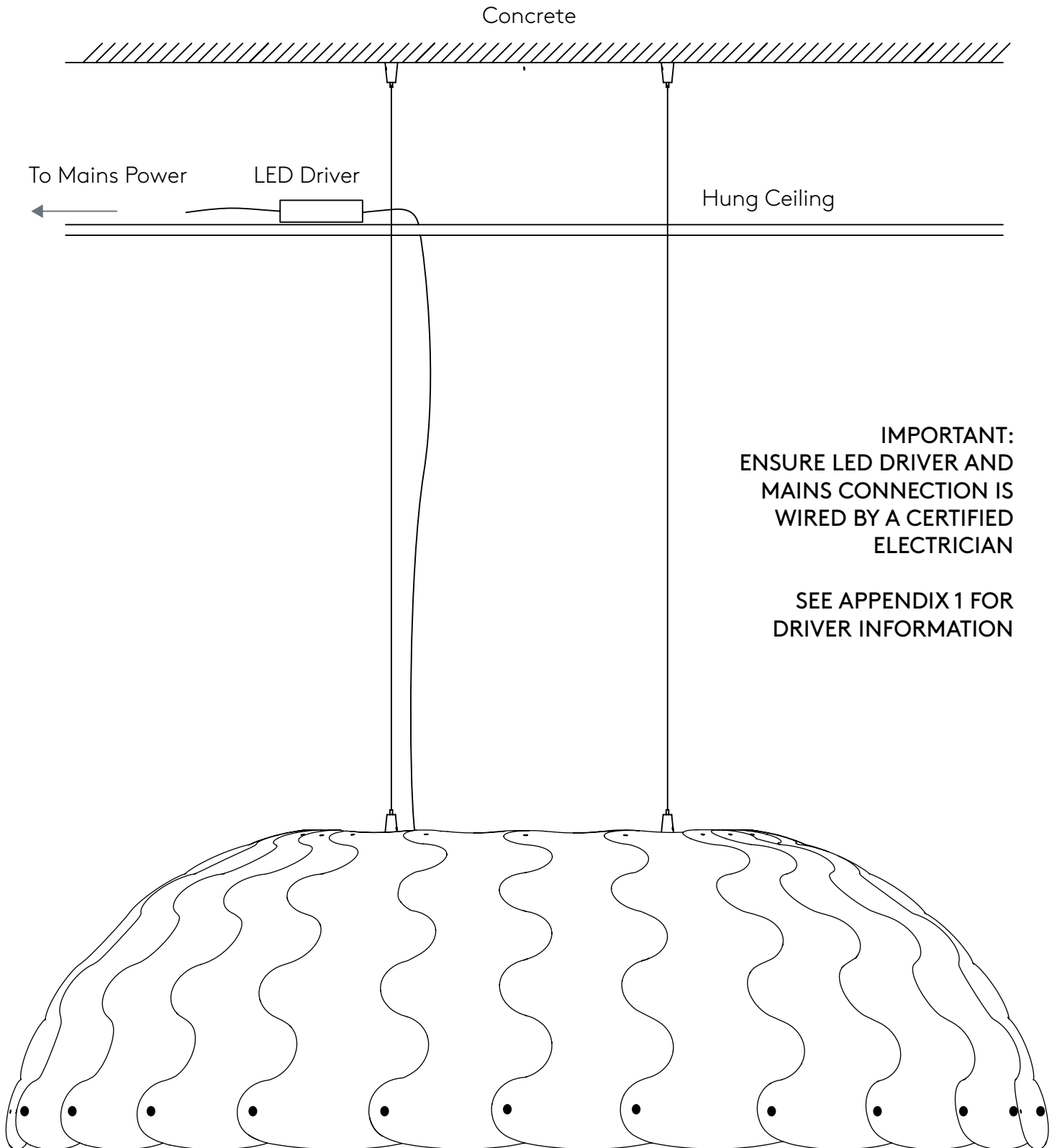

---

## Appendix 1: LED Driver Diagram

---

MEANWELL 16W Single Output C Dimmable LED Power Supply  
(PCD-25-700A)

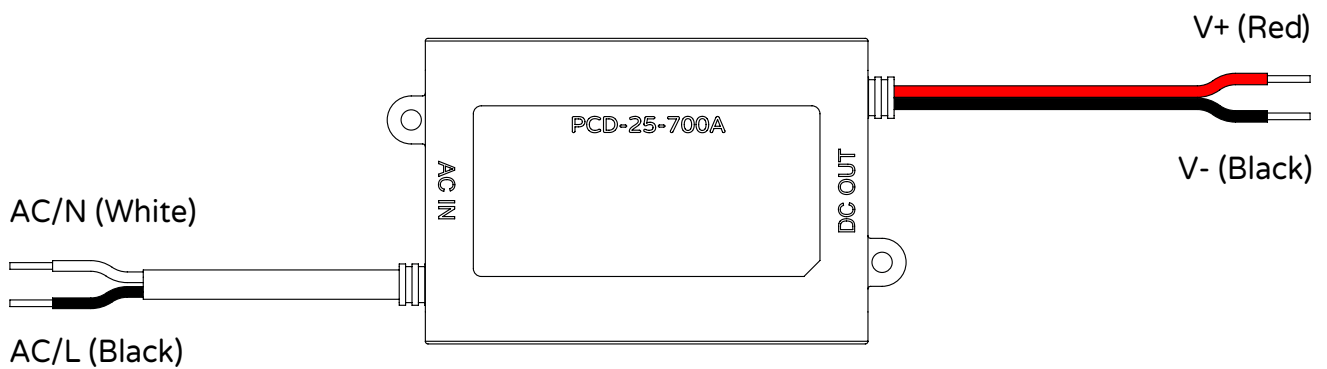

**IMPORTANT:**  
THIS PRODUCT MUST BE INSTALLED IN ACCORDANCE  
WITH THE APPLICABLE INSTALLATION CODE BY A  
PERSON FAMILIAR WITH THE CONSTRUCTION AND  
OPERATION OF THE PRODUCT AND THE HAZARDS  
INVOLVED

---

Appendix 2: Access to LED Lights for maintenance

---

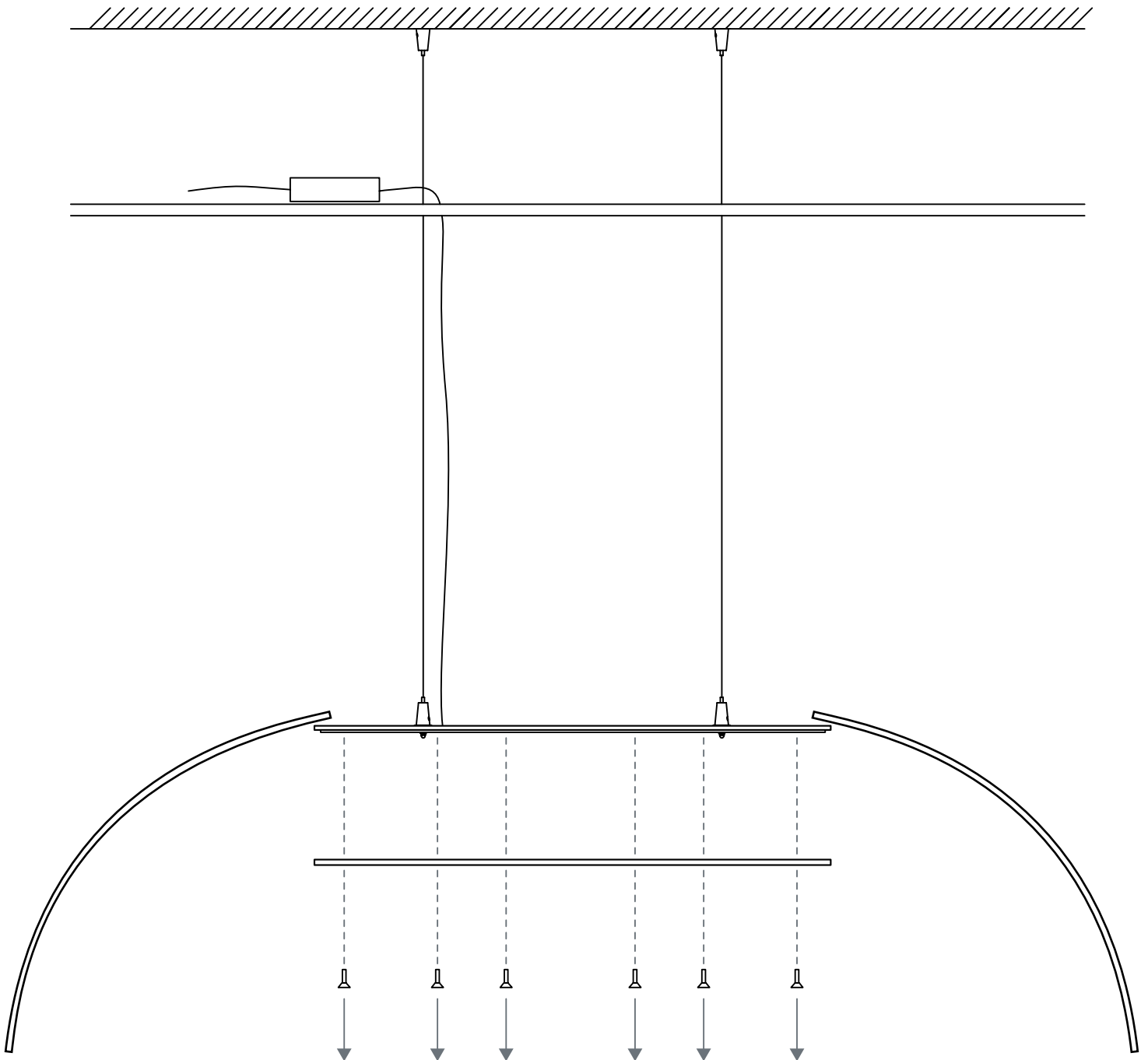

To gain access to the LEDs, remove the 12 small nuts and screws around the perimeter.

Appendix 3: Top Panel Sub Assembly

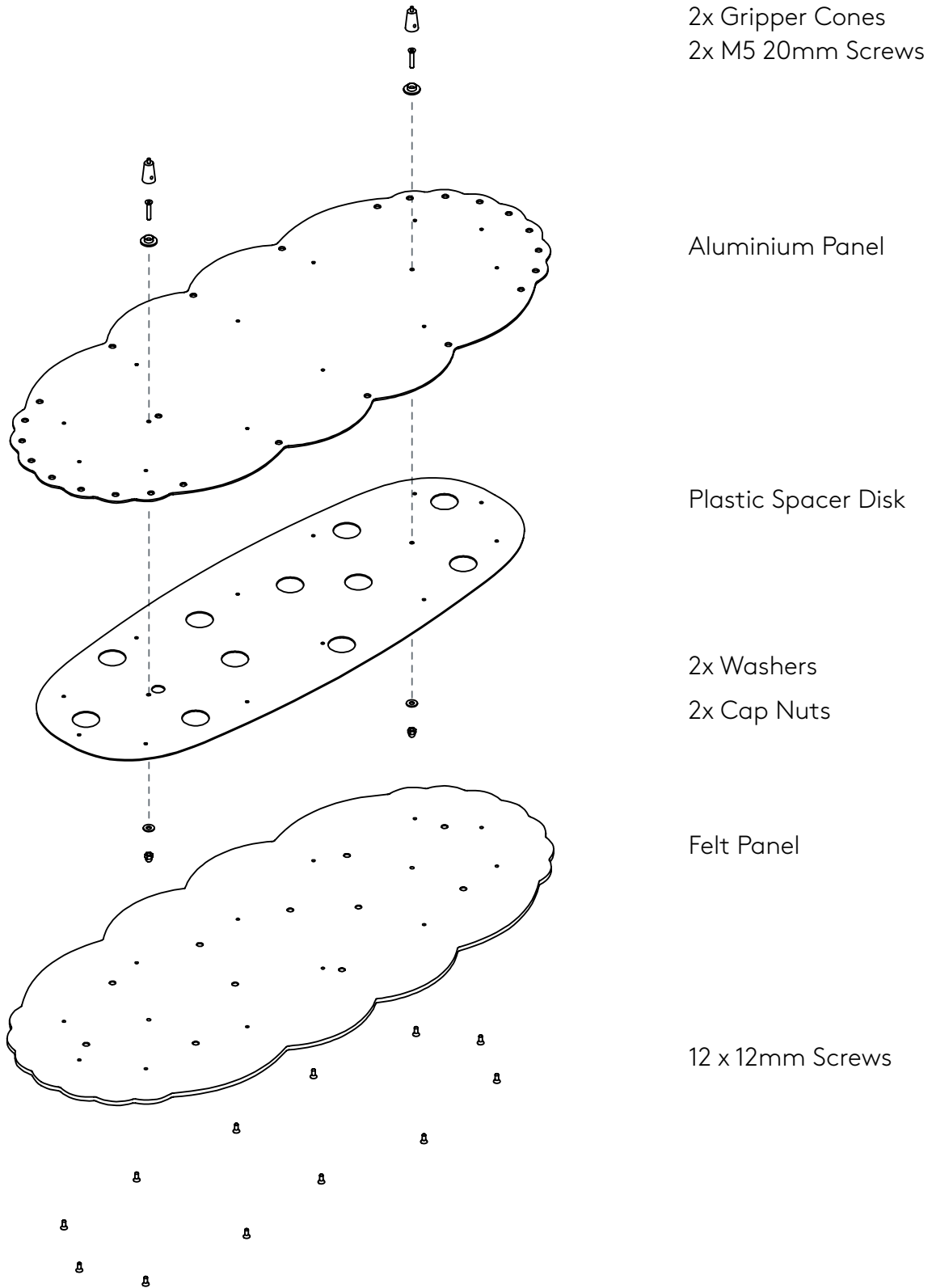

Exploded View